

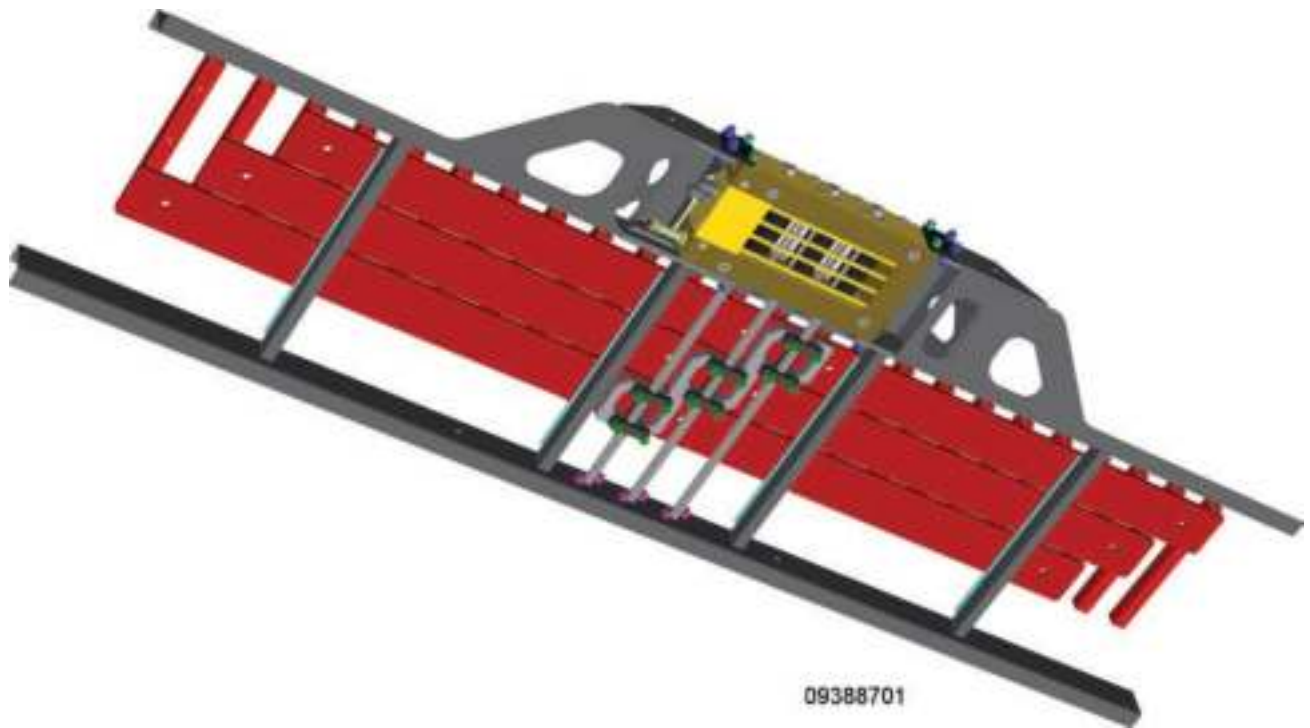

KMD 175

KEITH Manufacturing Co.
www.KeithWalkingFloor.com
World Headquarters
Toll-Free: 800-547-6161
Phone: +1-541-475-3802



OWNER / OPERATOR MANUAL

Original Instructions

©2022 KEITH Manufacturing Co. All Rights Reserved. KEITH, KEITH logo and WALKING FLOOR are registered trademarks of KEITH Manufacturing Co. Equipment manufactured by KEITH Manufacturing Co. is protected by numerous patents both domestic and foreign.

Released: 2022-09-20

DOC06357 Rev. G

Table of Contents

Introduction	iii
Declaration of Incorporation	iv
KEITH® WALKING FLOOR ® Unloading System Limited Warranty	v
Warranty Registration Card	vii
1.0 Safety	1
1.1 General Safety	1
1.1.1 Intended Function and Expected Use:	1
1.1.2 Improper Use	1
1.1.3 Training	2
1.1.4 Personal Protective Equipment	2
1.1.5 Airborne Noise Emission	2
1.1.6 Temperature	2
1.1.7 Lighting	2
1.1.8 Movement Around the System	2
1.1.9 Hydraulic Oil Safety	3
1.2 Design / Installation Safety	3
1.2.1 Kit Components	3
1.2.2 Installation	3
1.2.3 Danger Zones	3
1.2.4 Electric Components and Installation	3
1.2.5 Hydraulics	3
1.2.6 Controls	4
1.3 Marking of Machinery	5
1.3.1 Safety Decals	5
1.3.2 Serial Plate	8
2.0 Specifications	9
2.1 Hydraulic Drive Unit	9
2.2 General Wet Kit Specifications	10
2.3 Wet Kit Diagram	11
3.0 Operation	12
3.1 How It Works	12
3.2 Oil Flow Diagrams	13
3.3 Component Location Guide	15
3.4 Component Descriptions	16

Operating Instructions

3.5	Start Up	17
3.5.1	Before Initial Start-Up	17
3.5.2	After initial 6 working hours (first week of operation)	17
3.6	Pre-Trip Checklist	17
3.7	Standard Operating Procedures	18
3.7.1	Manual Controls	18
3.7.2	Electric On/Off, Manual Load/Unload - Wireless Remote Control - Type I	19
3.7.3	Electric On/Off & Electric Load/Unload - Wireless Remote Control - Type I	22
3.7.4	Electric On/Off & Electric Load/Unload - Wireless Remote Control - Type II	25
3.7.5	Electric On/Off & Electric Load/Unload - Cabled Pendant - Type I	28
3.7.6	Electric On/Off & Electric Load/Unload - Cabled Pendant - Type II	29
3.7.7	Manual Override of Electric Controls (if equipped)	30
4.0	Maintenance	32
4.1	Life Extending Practices	32
4.2	Preventative Maintenance	32
4.2.1	Monthly Service (25 operating hours)	32
4.2.2	6-Month Service (150 operating hours)	32
4.3	Bolt Torque Requirements	33
4.4	Cross-Drive Wear Component Diagram	34
4.5	Flooring Wear Component Diagrams	35
5.0	Troubleshooting	36
5.1	Check List	36
5.2	Problem / Solution - Troubleshooting	36
5.3	Adjustments & Repairs	38
5.3.1	Check Valve Replacement	38
5.3.2	Cylinder Pack Replacement	39
5.4	Technical Support	42
6.0	Contact Information - KEITH Manufacturing Co.	42

Introduction

We at KEITH Manufacturing Co. are very happy you have decided to equip your trailer with the KEITH® *WALKING FLOOR*® system. We take great pride in manufacturing the simplest, lowest maintenance self-unloading system available. Installing the KEITH® *WALKING FLOOR*® system in your trailer provides you with the versatility to load or unload virtually any type of material.

The following pages contain information on the operation of your KEITH® *WALKING FLOOR*® system. Further support and safety documents (manuals, brochures, and product specs) can be viewed or downloaded from our website at www.KeithWalkingFloor.com.

In addition, we have provided general information on the type of hydraulic wet kit that will be needed to operate your system. Please contact a KEITH sales representative or visit our website for more specific recommendations regarding pumps, filters, pressure relief valves and approved equivalent equipment. It is critical to adhere to the outlined hydraulic wet kit specifications. Failure to follow the guidelines concerning required operation pressures can lead to system failure due to excessive heat buildup.

Please review the entire manual before operating the KEITH® *WALKING FLOOR*® system. If you have any questions, please call 541-475-3802 or email Sales@KeithWalkingFloor.com where our support team will happily assist you.

Thank you again for putting your trust in our company!

Sincerely,



R. Mark Foster
President

DOC06344 Rev A

Declaration of Incorporation

Manufacturer:

KEITH Manufacturing Co.
401 NW Adler Street
Madras, OR 97741
USA

Hereby declares that the following partly complete machinery,

KMD-175 system mobile kit, serial numbers from year 2013 onward

Complies with the following essential health and safety requirements of Directive 2006/42/EC: 1, 2, 3, 4, 1.1.1, 1.1.2, 1.1.3, 1.1.5, 1.1.6, 1.1.7, 1.3.1, 1.3.2, 1.3.4, 1.3.6, 1.3.9, 1.5.3, 1.5.4, 1.5.5, 1.5.6, 1.5.8, 1.5.9, 1.5.15, 1.6.1, 1.6.2, 1.6.4, 1.7.1, 1.7.1.1, 1.7.2

The relevant technical documentation is compiled in accordance with part B of annex VII.

In response to a reasoned request by national authorities, relevant information on the partly complete machinery will be transmitted as hard copies or digital files, unconstrained by intellectual property rights.

This partly completed machinery must not be put into service until the final machinery into which it is to be incorporated has been declared in conformity with the provisions of Directive 2006/42/EC.

The person authorized to compile the technical file is:

KEITH WALKING FLOOR Europe
Harselaarsweg 113
3771 MA Barneveld
The Netherlands



R. Mark Foster
President

Madras, Oregon, USA December 3, 2013

DOC06197 Rev A

KEITH® WALKING FLOOR® Unloading System Limited Warranty

1 Year Limited Warranty & 2 Year Limited Hydraulic Warranty

KEITH Manufacturing Co. hereby warrants, to the first owner of a new **KEITH® Unloading System** from the factory or selling distributor, that the product shall be free from defects in material and workmanship for a period of **one year** after delivery or sale to the first registered owner. The **hydraulic drive system** has a **two year** limited warranty on all hydraulic parts and components. This warranty does not cover normal wear and tear and maintenance. A warranty card must be filled out and returned to **KEITH Manufacturing Co.** to activate this warranty.

Unloading system must only be used as recommended by KEITH Manufacturing Co. for normal use and service. This means the loading and/or unloading of uniformly distributed, non-corrosive material, properly restrained and secured, on properly maintained public roads, with gross vehicle weights not in excess of factory rated capacity. For stationary installations, normal use and service means the conveying of uniformly distributed, noncorrosive materials, with weights not in excess of factory rated capacity. The system must be installed according to **KEITH Manufacturing Co.** installation instructions. Preventative maintenance must be performed at regular intervals as specified in **KEITH Manufacturing Co.** manuals. **See below for circumstances that void the KEITH limited warranty.**

Sole and Exclusive Remedy: If the product covered hereby fails to conform to the above stated warranty, **KEITH Manufacturing Co.**'s sole liability under this warranty and the owner's sole and exclusive remedy is limited to repair or replacement of the defective part(s) at a facility authorized by **KEITH Manufacturing Co.**

THE WARRANTY SET FORTH ABOVE IS EXPRESSLY MADE IN LIEU OF ANY OTHER WARRANTIES, EXPRESS, IMPLIED, OR STATUTORY. KEITH MANUFACTURING CO. MAKES NO WARRANTIES OF FITNESS FOR A PARTICULAR PURPOSE OR WARRANTIES OF MERCHANTABILITY. FURTHER, KEITH MANUFACTURING CO. WILL NOT BE LIABLE FOR INCIDENTAL OR CONSEQUENTIAL DAMAGES SUCH AS, BUT NOT LIMITED TO, THE LOSS OF USE OF THE PRODUCT, DAMAGE TO THE PRODUCT, ATTORNEY'S FEES AND THE LIABILITY IN RESPECT TO ANY OTHER REASON.

TORT DISCLAIMER: KEITH MANUFACTURING CO. EXCLUDES ANY LIABILITY IN TORT WITH RESPECT TO THEIR PRODUCTS, INCLUDING ANY LIABILITY BASED ON STRICT LIABILITY IN TORT AND NEGLIGENCE.

If This Warranty Violates Law: To the extent any provision of this warranty, contravenes the law of any jurisdiction, that provision shall be inapplicable in such jurisdiction and the remainder of the warranty shall not be affected thereby.

Warranty Return Policy

Any defective part(s) must be shipped freight prepaid to the nearest **KEITH** facility. Please contact **KEITH** for additional information on proper locations. Before returning any item for repair or replacement, contact **KEITH Manufacturing Co.** at 1-800-547-6161 or TechDept@KeithWalkingFloor.com for a "Returned Goods Authorization" (RGA) number. Make sure the RGA number is on the outside of the shipping carton and all paperwork is included.

The following information is needed:

- | | |
|-----------------|------------------------------|
| a. Company name | e. Part number |
| b. Contact name | f. Quantity |
| c. Address | g. Reason for return |
| d. Phone number | h. Customer's account number |

The following circumstances void the KEITH Limited Warranty:

- Unloading system is not installed properly.
- Wet kit is not as recommended by KEITH or using an end dump or dump truck wet kit.
- Malfunction or problems caused by equipment which was not supplied by KEITH.
- Malfunction caused by improper repair work or repair work which is carried out by third parties.
- Malfunction caused using contaminated oil or oil of the wrong type.
- Malfunction caused by excessive heat over 140 °F [60 °C] due to a bad hydraulic pump on the truck or hydraulic wet kit or improper operation of the unloading system, for example, not fully opening and closing the ball valve.
- Defects in electrical components caused by incorrect connection and/or incorrect voltage levels.
- Preventative maintenance is not performed at regular intervals as specified in KEITH manuals.
- Malfunction caused by corrosive materials.
- Malfunction caused by overloading or improper use as stated in KEITH manuals.

Examples of wear items which are not covered by KEITH Limited Warranty:

- Floor seals
- Floor bearings
- Floor slats
- End plugs in slats
- Filter elements and components

Warranty Registration Card

Note: To validate the warranty, the registration information must be filled out completely and returned to KEITH within ten (10) days of purchase and/or installation.

Please fill out the Warranty Registration form on our website at www.KeithWalkingFloor.com or fill out the Warranty Registration Card below and mail or email it to:

KEITH Manufacturing Co.
P.O. Box 1
Madras, OR 97741-0001

TechDept@KeithWalkingFloor.com

This warranty registration card must be completed and on file at KEITH in order for the warranty period to begin on the purchase date. If no purchase date is registered, the beginning of the warranty will automatically revert to the manufacture date.

Name / Company Name: _____

Address: _____

City, State / Prov.: _____ Postal Code: _____

Country: _____

Phone: _____

E-Mail: _____

SYSTEM DATA:

Date of Purchase: _____

Model / Serial Number: _____

Purchased From: _____

Type of Material Loaded/Unloaded: _____

I have fully read the KEITH Manufacturing Co. warranty information and fully understand and agree to the terms of the warranty.

Name: _____ Date: _____ Signature: _____

1.0 Safety

1.1 General Safety

1.1.1 Intended Function and Expected Use:

1.1.1.1. The KEITH® *WALKING FLOOR*® system is a reciprocating slat conveyor primarily intended to load, hold, or unload bulk materials. It can also handle unit loads such as pallets by using special handling techniques and possibly additional safety controls. The system is supplied as a kit primarily intended for installation into mobile trailers or truck bodies. The floor is often loaded through an open trailer top or through the rear doors. The floor typically discharges material out the rear door. It is hydraulically actuated, powered by a pump mounted either to a PTO or an electric motor. The basic system is controlled by mechanically-actuated valves, but has the option for electrically-actuated valves. The system is compatible with options and accessories to improve performance. For example, it can be electrically controlled by hardwired switches or a wireless remote. A KEITH® *WALKING FLOOR*® Sweep System can improve clean out. Floor slat styles are selected based on the materials to be conveyed. The standard system handles a wide array of materials in a non-hazardous, non-explosive environment. Special modifications may be required for special environments like food-grade applications or explosive conditions.

1.1.2 Improper Use

- 1.1.2.1. This equipment has been manufactured utilizing state-of-the-art technology in accordance with acknowledged safety regulations. Nevertheless, dangerous situations could arise from improper use, which could endanger life and limbs of personnel and cause severe damage to the equipment and other assets. This equipment may only be used for its intended purpose. It may only be operated in impeccable technical condition and in accordance with the proper use and this user manual. Problems, which could affect safety, must be resolved immediately. The manufacturer is not liable for any damage caused by improper use or arbitrary modifications. The installation, commissioning, operation, and maintenance instructions must be followed as outlined in this manual.
- 1.1.2.2. Personnel must not enter the danger zone(s) when the system is enabled. Specifically, nobody should be inside, under, or behind the trailer in the unloading zone during operation. Additionally, no one should be in a full or filling trailer. Lock-out and tag-out procedures must be followed before accessing the drive area.
- 1.1.2.3. The maximum load capacity must not be exceeded. (See 2.0 Specifications section)
- 1.1.2.4. The hydraulic power source must not exceed the pressure and flow ratings. Install a relief valve to ensure the maximum pressure is not exceeded.
- 1.1.2.5. Control circuitry must not be altered or bypassed.
- 1.1.2.6. Safeguards must not be altered or bypassed.
- 1.1.2.7. The floor structure must not be altered.
- 1.1.2.8. The floor should not be used to handle any material other than specified.
- 1.1.2.9. The user and system designer must understand the characteristics and safe handling requirements of the material that is being conveyed.
- 1.1.2.10. Bulk materials are by nature unstable and flowable. Avoid burial by avoiding contact with the material.

1.1.3 Training

- 1.1.3.1. Operators must read and understand this manual before operating or maintaining the machine. Only qualified, trained personnel may execute commissioning, operation, and maintenance of the system.

1.1.4 Personal Protective Equipment

- 1.1.4.1. Always wear protective equipment appropriate for risks associated with each phase of the system's life, including transportation, installation, assembly, operation, inspection, maintenance, and dismantling, disabling, and scrapping. As a minimum, this includes the following personal protective equipment:

- Safety glasses
- Protective/traction shoes
- Gloves
- Welding/grinding protection
- Helmets
- Thermal protection such as coats
- Hearing Protection

1.1.5 Airborne Noise Emission

- 1.1.5.1. There is not a defined workstation; sound pressure levels emitted by the *WALKING FLOOR*® modules were measured at a height of 1.6 meters from the floor surface and a distance of 1 meter from the surface of the *WALKING FLOOR*® system at the drive area.

- The A-weighted emission sound pressure level = 74.8 dB
- The peak C-weighted instantaneous emission sound pressure level = below 130 dB [63 Pa]

- 1.1.5.2. Slower floor speeds result in less noise.

1.1.6 Temperature

- 1.1.6.1. Operation of the system generates heat in the hydraulic oil. Hot oil can damage the internal seals, resulting in a failure to operate.
- 1.1.6.2. Overheated oil can degrade rapidly. Hot oil and the resulting hot surfaces can cause burns. Do not allow the oil temperature to exceed 140 °F [60 °C].
- 1.1.6.3. KEITH recommends some or all of the following temperature control measures depending on the circumstances. High duty cycle systems and hot environments will require more control measures.
- Maintain adequate oil level in the reservoir.
 - Install a thermometer or sensor to monitor oil temperature.
 - Install a cooler.
 - Set a sensor to automatically shut down the system if oil temperature exceeds 140 °F [60 °C].

1.1.7 Lighting

- 1.1.7.1. Do not use or service the system in an environment of insufficient light.

1.1.8 Movement Around the System

- 1.1.8.1. Hydraulic oil can be slippery. Clean up oil spills immediately.

1.1.9 Hydraulic Oil Safety

- 1.1.9.1. See the Material Safety Data Sheet (MSDS) for the oil used in your system for further information about hydraulic oil safety.
- 1.1.9.2. In an accident involving high pressure equipment, hydraulic oil may be injected under the skin. Such an accident may result in a small, sometimes bloodless, puncture wound. However, due to the system's driving force, material injected into a fingertip can be deposited into the palm of the hand. Within 24 hours, there is usually a great deal of swelling, discoloration, and intense throbbing pain. Immediate treatment at a surgical emergency center is recommended.
- 1.1.9.3. Do not use high pressure systems in the vicinity of flames, sparks, and hot surfaces. Use only in well ventilated areas.
- 1.1.9.4. Use only designated appropriate fill and drain ports for the oil.

1.2 Design / Installation Safety

1.2.1 Kit Components

- 1.2.1.1. The kit consists of a drive unit, flooring, and miscellaneous boxed parts. These modules are intended to be anchored in a shipping frame or stacked flat and braced with dunnage for shipping and storage.

1.2.2 Installation

- 1.2.2.1. Use designated lifting points if provided on drive or shipping frame.
- 1.2.2.2. Only use equipment with appropriate capacity ratings to lift and handle components.
- 1.2.2.3. Use appropriate lifting procedures when handling loose or boxed components.
- 1.2.2.4. The floor must be installed far enough away from other equipment or fixtures to prevent the moving parts of the floor module from creating a crush or pinch hazard.

1.2.3 Danger Zones

- 1.2.3.1. The reciprocating action of the floor creates pinch and shear points by nature. Specifically, drive area cylinder, cross-drive, and slats approaching each other, frame components, or walls. These and any other relevant exposed areas must be guarded.
- 1.2.3.2. The floor must be incorporated into surroundings such that movement of the material on the floor does not create crushing, burial, drawing in, or entrapment hazards. The system must be designed to limit access to the material flow path.

1.2.4 Electric Components and Installation

- 1.2.4.1. KEITH recommends connecting to earth ground (whenever possible).
- 1.2.4.2. Wiring must be connected consistent with local codes and regulations, including electromagnetic interference regulations.
- 1.2.4.3. Adequate electric overcurrent protection must be provided.

1.2.5 Hydraulics

- 1.2.5.1. Hydraulic piping and components must be constructed of materials that are rated for system pressures, and must be installed with best industry practices. Follow all pipe, tubing, fitting, and hose manufacturer installation and routing guidelines.
- 1.2.5.2. Hydraulic piping should be supported and isolated from vibration. Contact KEITH for recommendations on installation.
- 1.2.5.3. Place protective shrouds around the hydraulic tubing in any areas that may have operators or people frequently nearby.

1.2.6 Controls

- 1.2.6.1. The control panel must be located such that it is easily accessible for all sizes and capacities of people, and allows the operator to move freely (whenever applicable).
- 1.2.6.2. Control devices must be located outside of danger zones, such that any exposed persons in danger zones are visible from the control station.
- 1.2.6.3. An acceptable means must be provided to monitor the status and movement of the load.
- 1.2.6.4. The floor can generate enormous horizontal force which can destroy improperly designed surroundings. The floor module must not be allowed to compact material against an end wall or door, or end walls and doors must be designed to absorb these forces.
- 1.2.6.5. Do not allow the floor to move material toward the front of the trailer when material is contacting the front wall. KEITH recommends installing limit switches to prevent this. In the absence of a sensor switch, the operator must be keenly aware of the load position, and the control system must require the operator to hold the run signal in the on position to continue running, such that releasing the run signal causes the floor to stop (momentary signal).
- 1.2.6.6. Material compacted against closed doors can force the doors open dangerously fast when the door latch is released. The impact can cause serious injury or death. Do not allow the floor to run when the doors are closed. Do not open a door when it is possible that material may be compacted against it. KEITH strongly recommends installing a control interlock switch to prevent the floor from running when the door is closed. KEITH also recommends a door latch that can be remotely actuated by someone away from the door area unload zone.

1.3 Marking of Machinery

1.3.1 Safety Decals

Safety Decal Placement Guide: KMD (Left Side Controls)

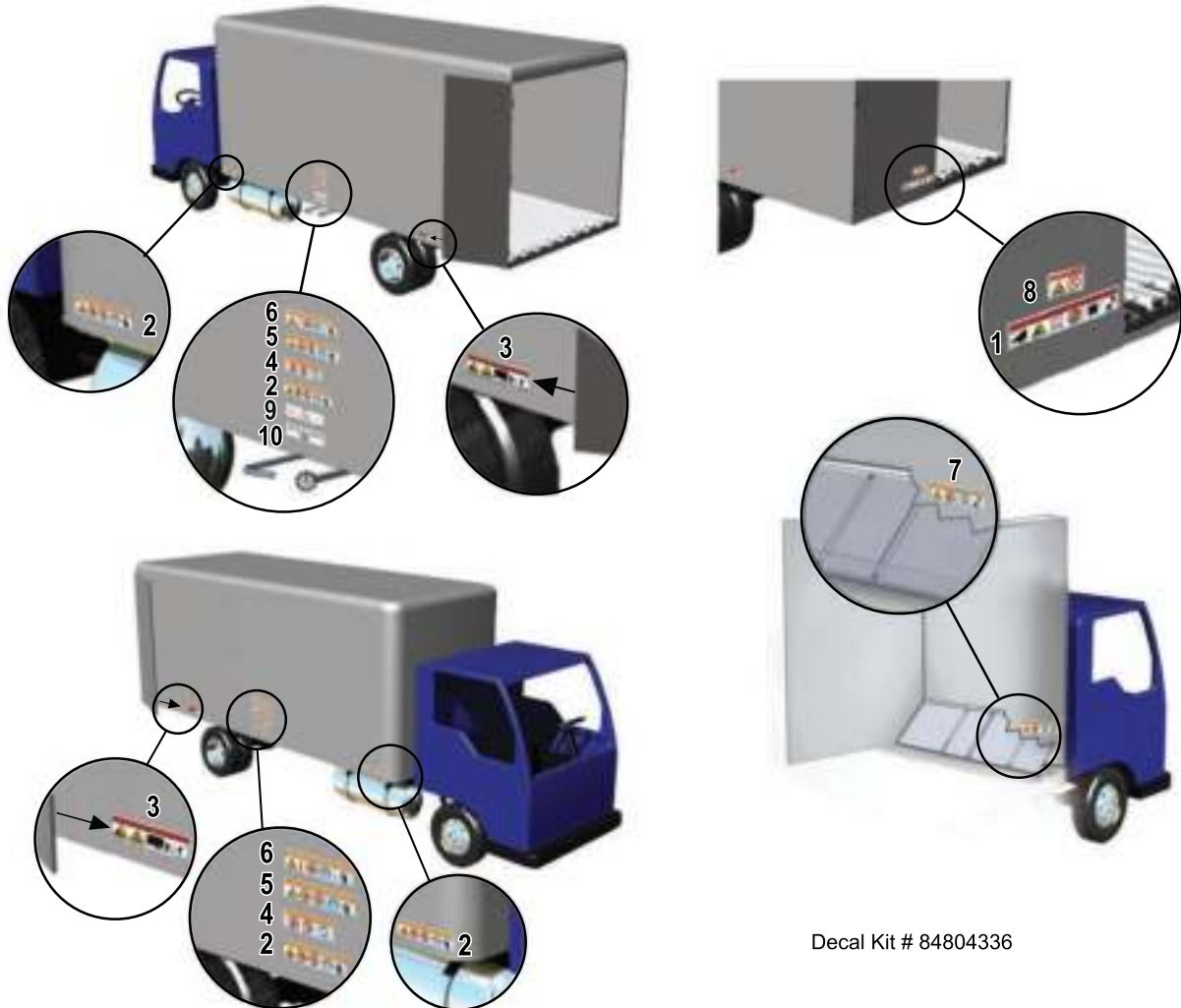





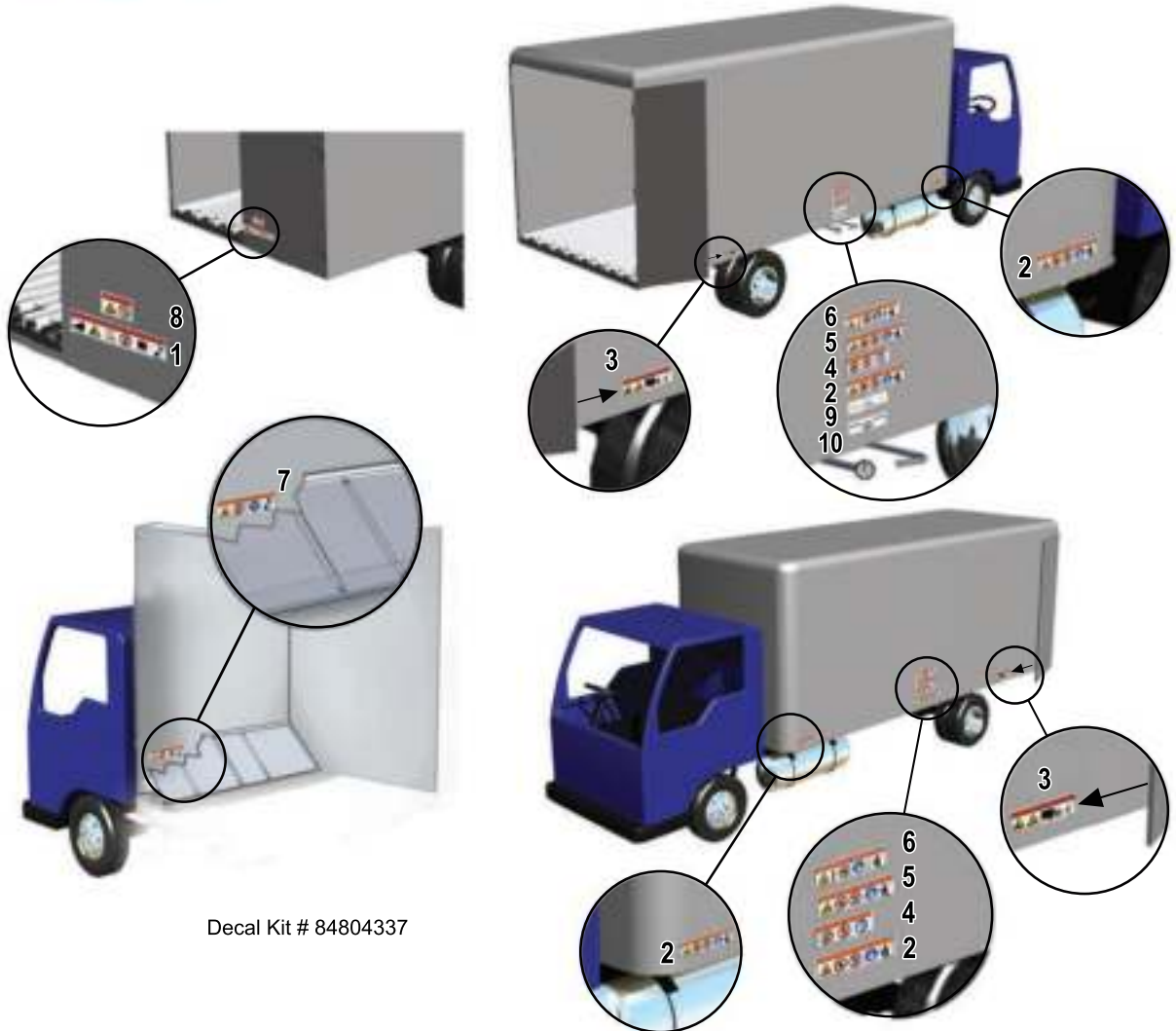













Decal Kit # 84804336

Safety Decal Placement Guide: KMD (Right Side Controls)

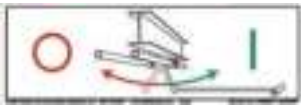

Decal Kit # 84804337

	Worded (Old - 2019)	Wordless (2020 - Future)	Description
1			Pressure can build when material is compacted. Doors can open violently causing serious injury or death. Do not operate floor with doors closed. Stay clear to open doors.
2			Pinch point can cut or crush causing serious injury. Stay clear during operation. Lockout/tagout before servicing.
3			Burial could cause serious injury or death. Stay clear during operation.
4			To avoid injury, you MUST read and understand technical manual before operating or servicing this machine.
5			Hydraulic pressure can cause serious injury. Stay clear during operation. Lockout/tagout before servicing.
6			Hot surface can cause severe burns. Do not touch. Turn off and lock out main power disconnect and allow to cool before servicing.
7			Avoid injury. Do NOT operate with guard removed. Replace guard before operating machine.
8			Burial could cause serious injury or death. Do Not Enter when being loaded.
9			Pull handle out to turn floor on. Push handle in to turn floor off.
10	Controls on <u>Left</u> Side of Truck/Trailer		Turn knob clockwise to unload. Turn knob counterclockwise to load.
10		 Controls on <u>Right</u> Side of Truck/Trailer	Turn knob clockwise to unload. Turn knob counterclockwise to load.

1.3.2 Serial Plate

Please fill in the information from the serial plate attached to your drive system (See 3.3 Component Location Diagram). Over time these plates become difficult to read or even locate and this information is crucial in determining the specific replacement parts for your system.

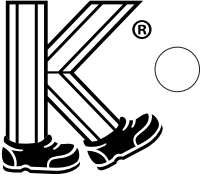
KEITH MANUFACTURING CO KEITH Manufacturing Co. World Headquarters 401 NW Adler St. Madras, OR 97741 USA <hr/> KEITH WALKING FLOOR Europe Harselaarseweg 113 3771 MA Barneveld The Netherlands www.KeithWalkingFloor.com	WALKING FLOOR® KMD MODEL: _____ SERIAL #: _____ D.O.M.: _____ LOAD CAPACITY: _____ MAX PRESSURE: _____ MAX FLOW: _____ DRIVE WEIGHT: _____ 
---	---

WALKING FLOOR and KEITH are registered trademarks of KEITH Manufacturing Co.

2.0 Specifications

2.1 Hydraulic Drive Unit

Drive Style:		KMD 175
Cylinder Bore Diameter:		1.75 in [44.5 mm]
Cylinder Stroke Length:		4.0 in [102 mm]
Required Relief Valve Pressure Range:	Min: Max:	2,800 PSI [195 bar] 3,000 PSI [210 bar]
Load Capacity:		5 tons [4.5 tonnes]
Pump Flow Rate:		0.5 - 5.5 gal/min [1.9 - 20.8 liters/min]
Recommended Pump Flow Rate:		0.5 - 5.5 gal/min [1.9 - 20.8 liters/min]
* Floor Speed:		1 - 8 ft/min [0.3 - 2.4 meters/min]
Maximum Temperature:		140 °F [60 °C]
** Drive Weight:		250 - 300 lbs [113 - 136 kg]

* Load/Unload times vary with pump flow rate, length of trailer, material type or other environmental variables.

** Varies by drive configuration and application.

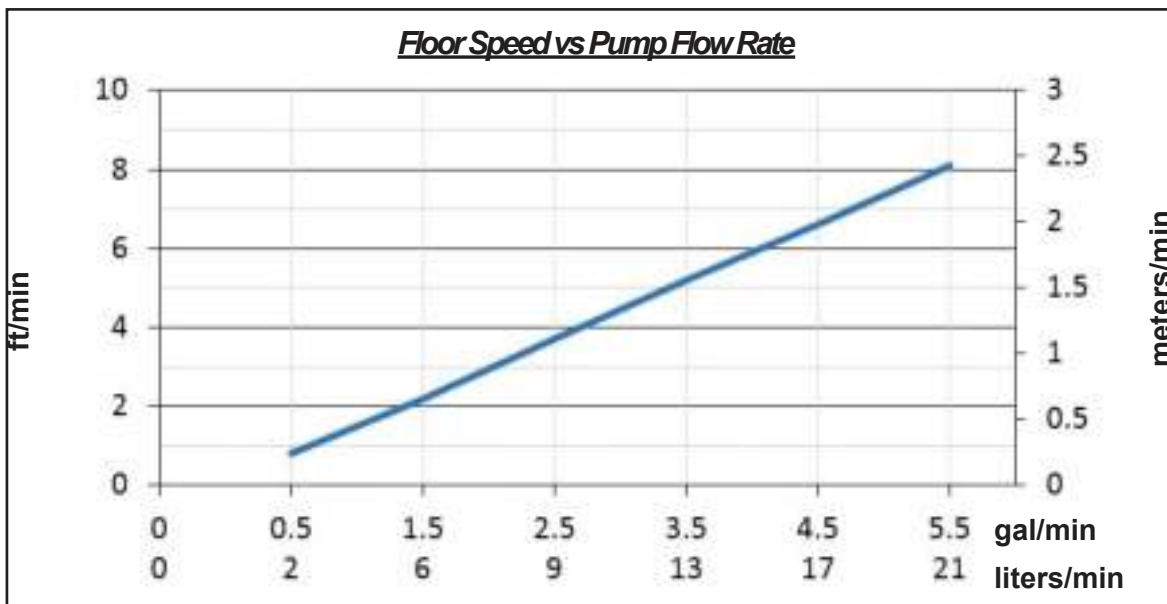

2.2 General Wet Kit Specifications

Oil	ISO-L-HM 46 hydraulic oil (As per ISO 11158). If operating the system below 32 °F [0 °C], AW ISO 32 hydraulic oil is recommended.
* PTO & Pump	<p>The PTO and Pump must be capable of producing a minimum flow rate of 0.5 gal/min at 3000 PSI [1.9 l/min at 210 bar] to make the system run.</p> <p>NOTE: Dump wet kit systems will not properly operate the <i>WALKING FLOOR</i>® unloader.</p> <p>NOTE: Pumps with built-in pressure relief valves are NOT recommended.</p> <p>Do not exceed the maximum pressure.</p>
Filter	<p>Filter should be double element, 10 micron, on the return line. (The filter element should be changed after 6 operating hours initially, and then every 6 months thereafter. This may vary with the operating environment).</p> <p>KEITH recommends, but does not require, installing an inline pressure filter to increase the life of the system.</p>
Hydraulic Reservoir	Sized to desired flow rate. Should hold approximately 1 gallon [1 liter] of oil for every gallon per minute [liter per minute] you plan to pump, i.e. 15 gal/min [57 liters/min] = 15 gallon [15 liter] reservoir. Minimum size 15 gallons [57 liters]
Suction Line	Unless tank is mounted above the pump, the suction line from the tank to the pump should be no more than 12 ft [3.7 m] in length with a minimum inside diameter of 3/4 inch [-12] [19 mm]. Must use suction hose ONLY!
Pressure Line	Hose from truck to trailer should be rated at 3000 PSI [210 bar] minimum with a minimum inside diameter of 1/2 inch [-8] [12.5 mm].
Return Lines	<p>Hose from trailer to wet kit filter should be rated at 3000 PSI [210 bar] minimum with a minimum inside diameter of 3/4 inch [-12] [19 mm].</p> <p>Hose from wet kit filter to reservoir tank should be rated at 3000 PSI [210 bar] minimum with a minimum inside diameter of 1 inch [-16] [25 mm].</p>
* Pressure Relief Valve	High quality valve, capable of relieving maximum pump flow rate at 3000 PSI [210 bar]. Relief valve must be set above cracking pressure ~2800 PSI [195 bar] and no higher than full open relief pressure ~3000 PSI [210 bar]
<p>Contact KEITH in your region for specific recommendations and advice regarding wet kits.</p>	

* If the information about your pump and pressure relief valve is not known, have a pressure/flow check done by a professional.

2.3 Wet Kit Diagram

IMPORTANT

To ensure proper operation of your KEITH® WALKING FLOOR®, the specifications and following diagram must be followed. Failure to comply with these instructions may void the KEITH® Warranty.

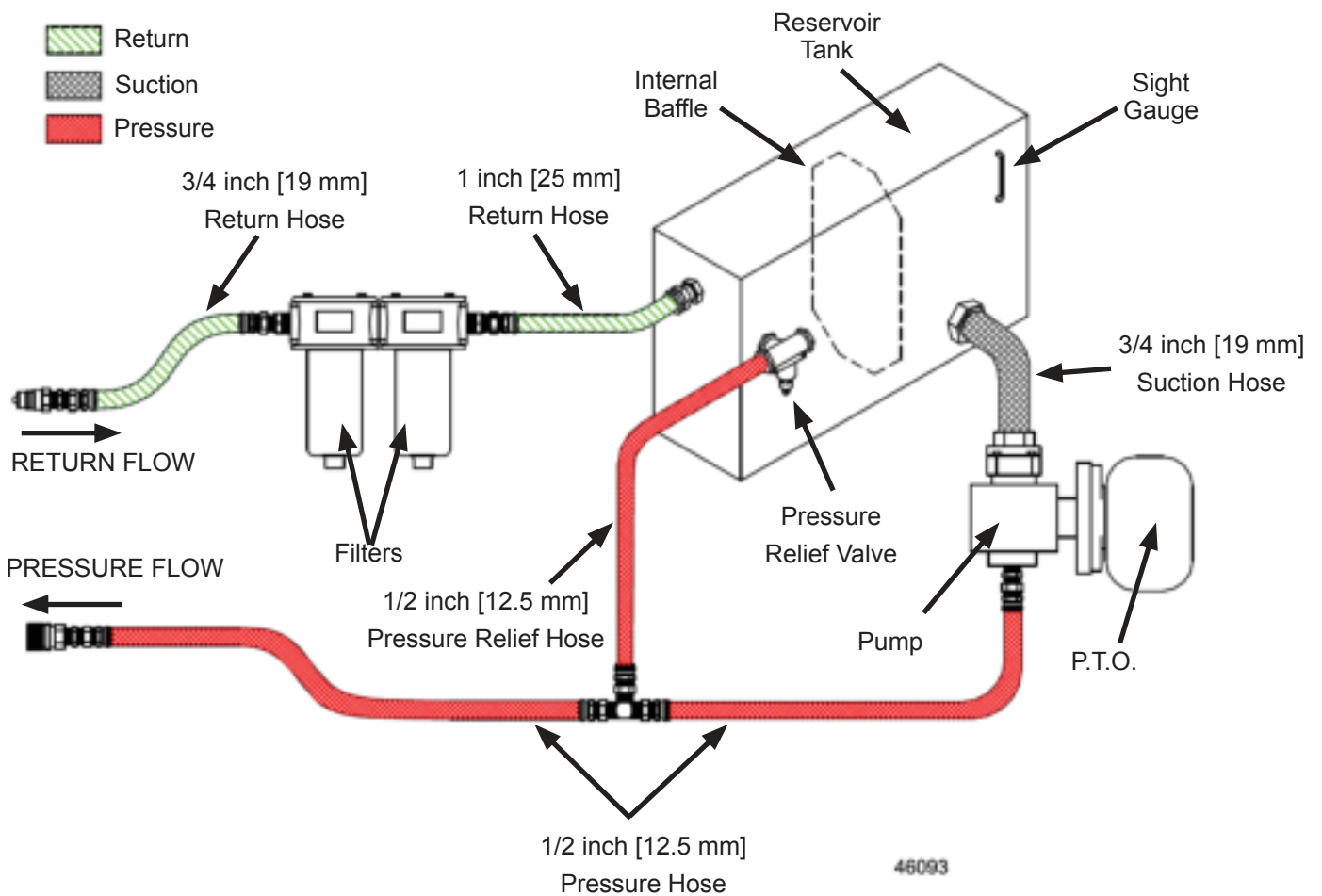

3.0 Operation

3.1 How It Works

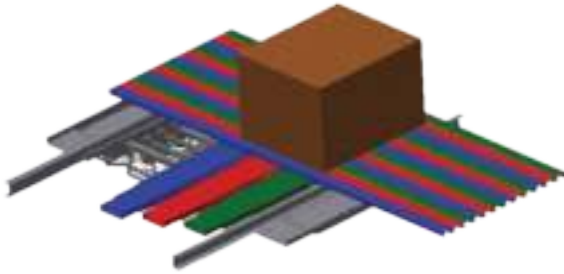

Initial Stage

All slats are staged together toward the direction of material travel (discharge end).

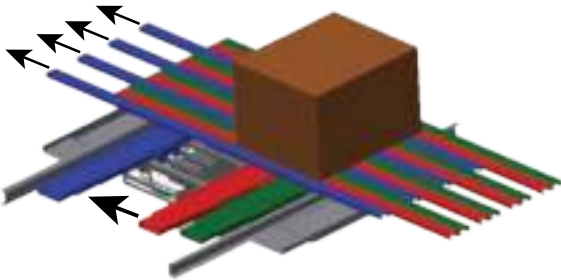

Stage 1

The first group of slats (approximately every 3rd slat) moves under the load.

Load does not move.

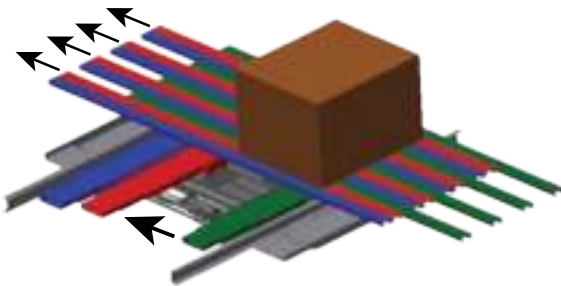

Stage 2

The second group of slats moves under the load.

Load does not move.

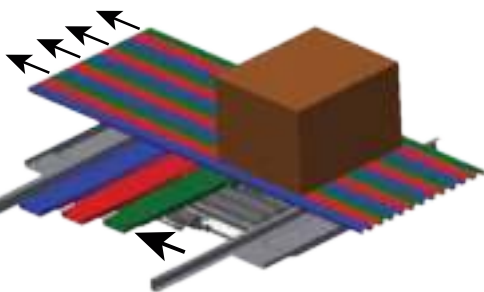

Stage 3

The final group of slats moves under the load.

Load does not move.

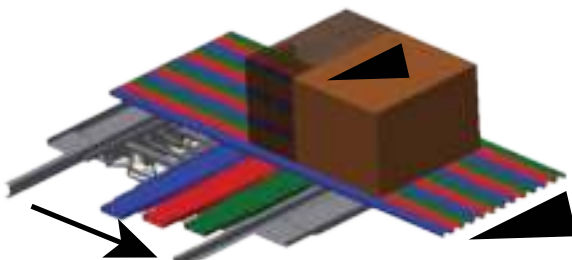

Stage 4

All slats move together.

Load moves with the floor toward the discharge end.

(Stages 1, 2 & 3 require more pressure than Stage 4.)

8175101

3.2 Oil Flow Diagrams

UNLOADING CYCLE

■ Pressure

■ Return

■ Blocked Return Oil

■ Standing Oil

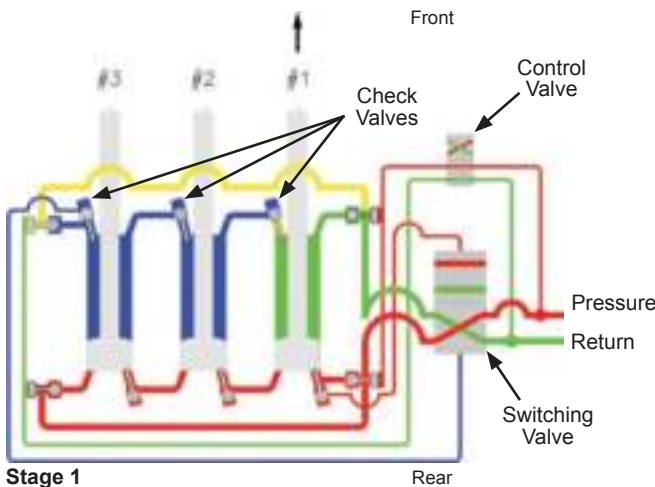

Stage 1

- Pressure in the rear of all cylinders.
- Cylinder #1 is open to return, causing it to move. (Load does not move.)
- Blocked by check valves.

Note: Stage 1 requires more pressure than stage 4.

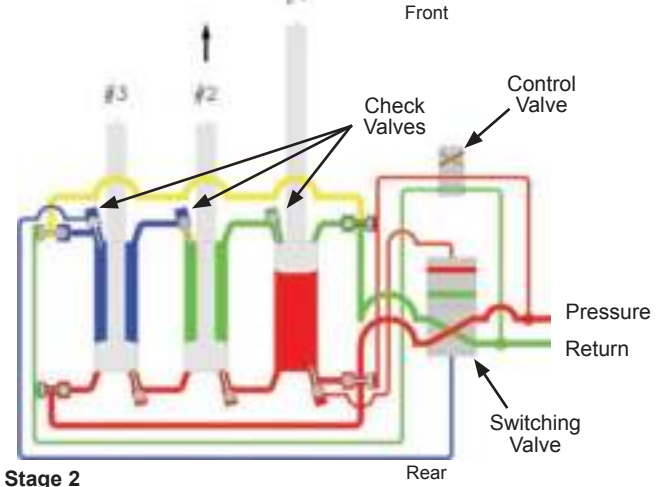

Stage 2

- Pressure still in rear of all cylinders.
- Cylinder #1 completes its full stroke, opening the check valve, allowing the oil in cylinder #2 to escape, causing it to move. (Load does not move.)
- Blocked by check valve.

Note: Stage 2 requires more pressure than stage 1.

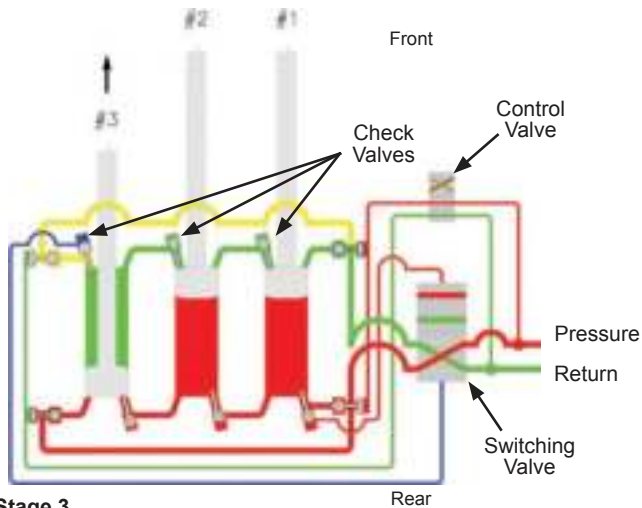

Stage 3

- Pressure still in rear of all cylinders.
- Cylinder #2 completes its full stroke, opening the check valve, allowing the oil in cylinder #3 to escape to return, causing it to move. (Load does not move.)

Note: Stage 3 requires more pressure than stage 2.

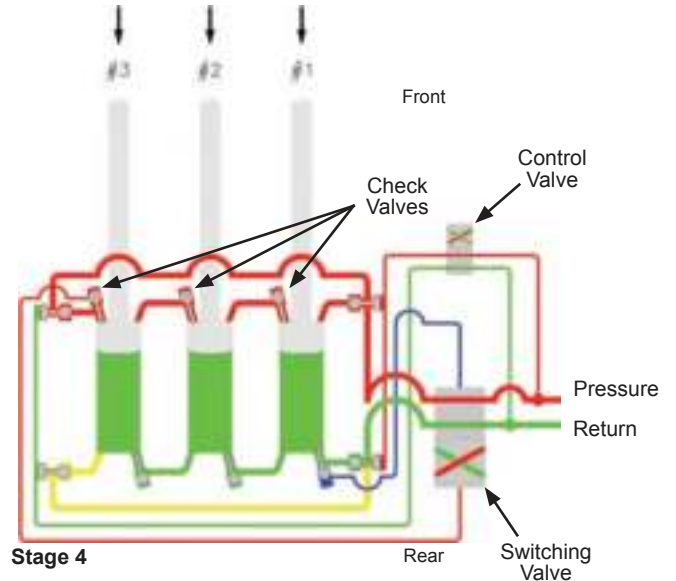

Stage 4

- Cylinder #3 completes its stroke, opening the check valve which shifts the switching valve, reversing pressure and return, transferring the pressure to the front of all cylinders.
- All cylinders are now open to return and move to the rear of the trailer together, moving the load.

As the cylinders complete their stroke, cylinder #1 shifts the switching valve, which reverses pressure and return, transferring the pressure to the rear of all cylinders again and the cycle starts over.

Note: Stage 4 requires less pressure than stages 1, 2, or 3.

LOADING CYCLE

■ Pressure
 ■ Return
 ■ Blocked Return Oil
 ■ Standing Oil

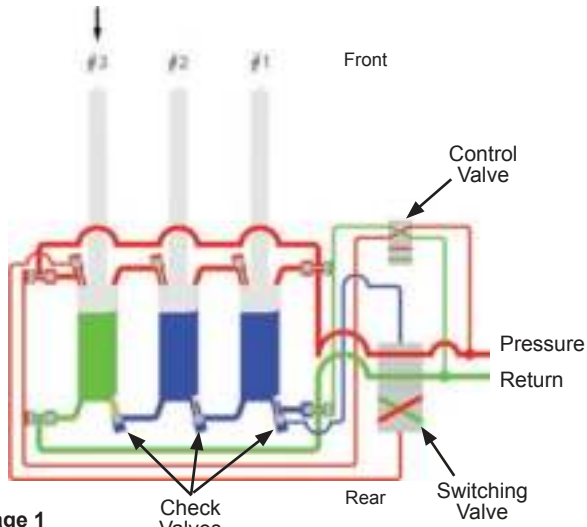

Stage 1

- Pressure in the front of all cylinders.
- Cylinder #3 is open to return, causing it to move. (Load does not move.)
- Blocked by check valves.

Note: Stage 1 requires more pressure than stage 4.

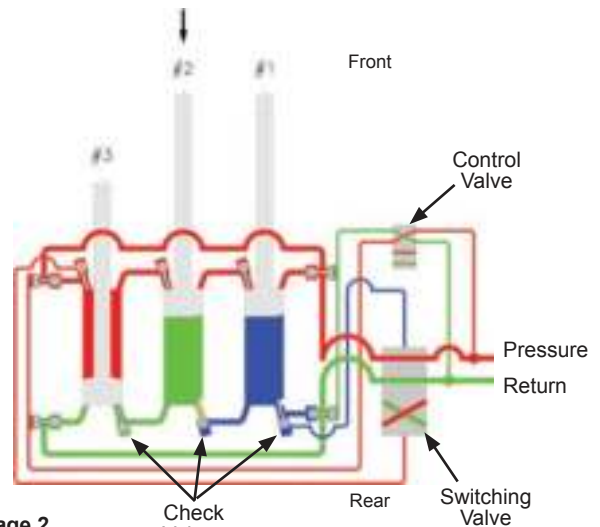

Stage 2

- Pressure still in front of all cylinders.
- Cylinder #3 completes its full stroke, opening the check valve, allowing the oil in cylinder #2 to escape, causing it to move. (Load does not move.)
- Blocked by check valve.

Note: Stage 2 requires more pressure than stage 1.

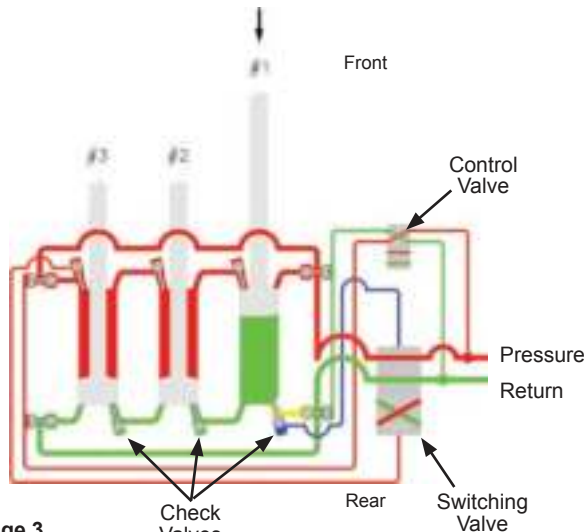

Stage 3

- Pressure still in front of all cylinders.
- Cylinder #2 completes its full stroke, opening the oil in cylinder #1 to escape to return, causing it to move. (Load does not move.)

Note: Stage 3 requires more pressure than stage 2.

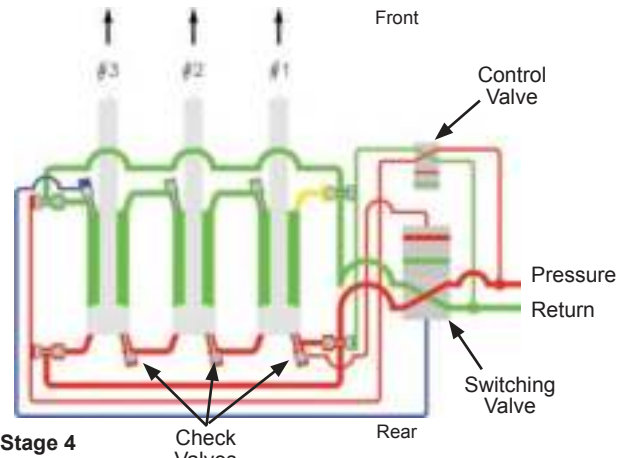

Stage 4

- Cylinder #1 completes its stroke, opening the check valve which shifts the switching valve, reversing pressure and return, transferring the pressure to the rear of all cylinders.
- All cylinders are now open to return and move to the front of the trailer together, moving the load.

As the cylinders complete their stroke, cylinder #3 shifts the switching valve, which reverses pressure and return, transferring the pressure to the front of all cylinders again and the cycle starts over.

Note: Stage 4 requires less pressure than stages 1, 2, or 3.

3.3 Component Location Guide

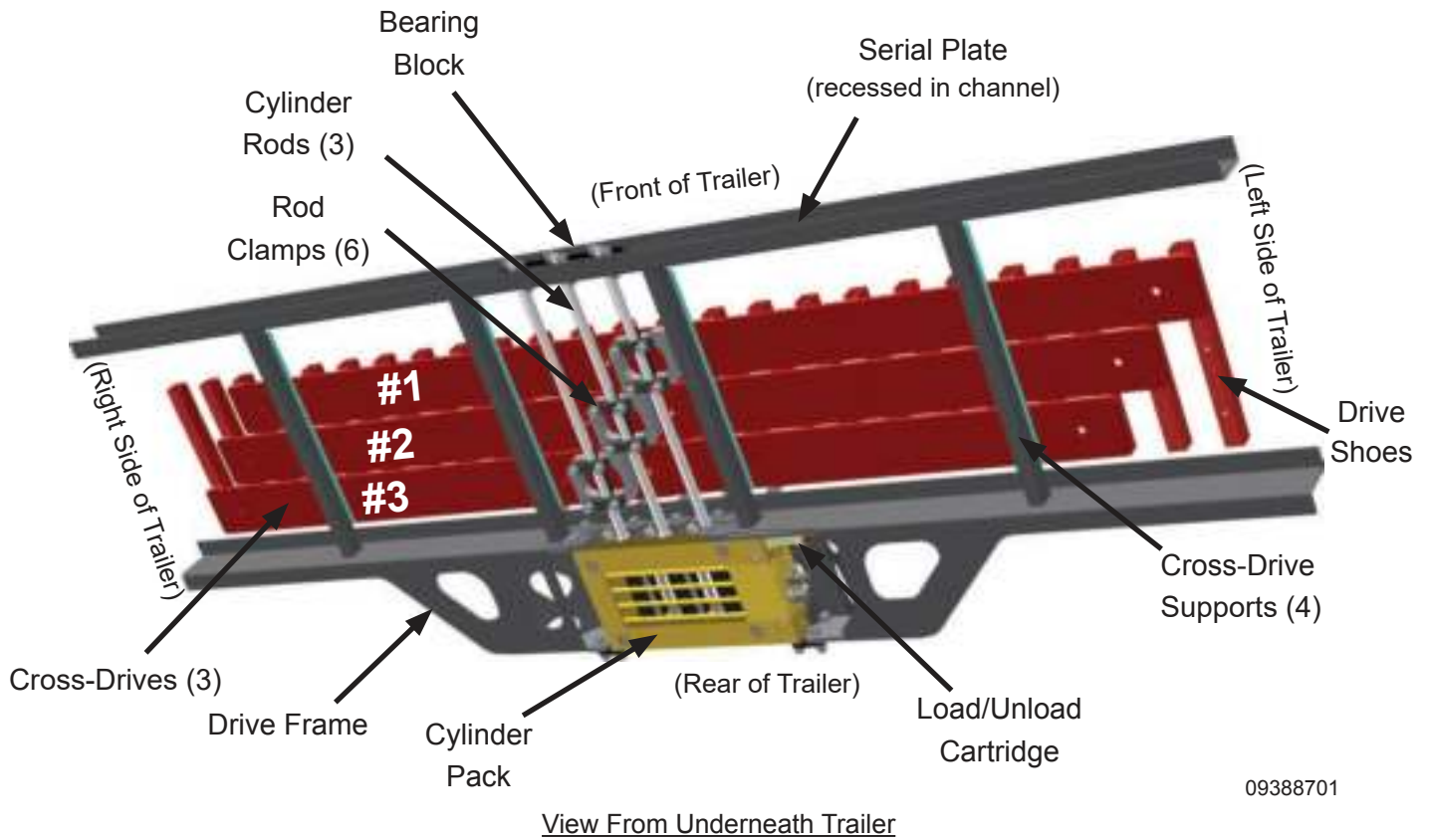

Manual Ball Valve Assembly Connections (If Equipped)

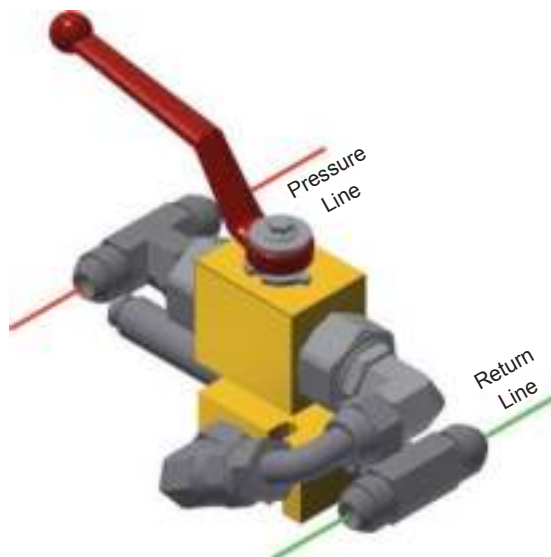

3.4 Component Descriptions

<u>Component</u>	<u>Description</u>
Ball Valve (On/Off)	A closed ball valve routes oil to the drive system (floor On). An open ball valve redirects it back to the tank (floor Off). Controls are available in manual and electric options.
Switching Valve	(Inside the cylinder pack) Switches the hydraulic pressure from one end of the cylinders to the opposite end of the cylinders, which causes the cylinders to change from the restaging sequence to moving the material then back again.
Load / Unload Cartridge	Controls which check valves are active, determining the direction of material movement (Load/Unload). (Manual or electric available)
Check Valves	Block oil flow, determining the cylinder restaging sequence.
Bearing Block	Supports the ends of the cylinder rods.
Cylinder Pack	Cylinders move the cross-drives.
Rod Clamps	Attach each cross-drive to a cylinder.
Cross-Drives	Each cross-drive is connected to one cylinder, allowing each cylinder to move multiple floor slats.
Drive Shoes	Connect the cross-drives to the floor slats and allow multiple floor slats to be attached to each cross-drive.
Cross-Drive Supports	Help maintain the position of the cross-drives over the mainframe rails.
Drive Frame	Provides structural rigidity and a surface to mount the drive to the trailer.

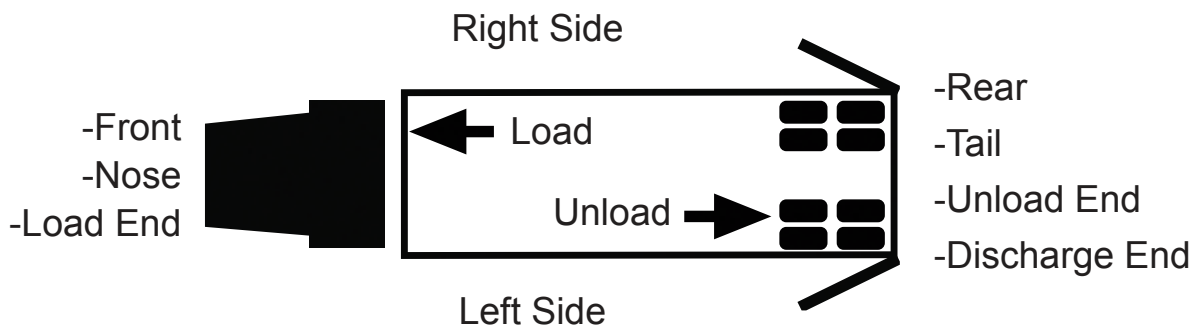

3.5 Start Up

3.5.1 Before Initial Start-Up

- Read through this manual. If there is any confusion, contact KEITH to resolve any concerns before operating this system (See 6.0 Contact Information section).
- Ensure that the hydraulic reservoir has the recommended amount of oil, as well as the correct type of oil (See 2.2 Specifications section or visit our website for additional details).
- Torque rod clamp bolts and floor bolts. (See 4.3 Maintenance section for special values and instructions.) Loose rod clamp bolts and flooring bolts are the most common cause of severe damage to the drive or flooring.
- Familiarize yourself with 4.2 Preventative Maintenance section of this manual. Following the maintenance schedule will significantly improve the life of the system.

3.5.2 After initial 6 working hours (first week of operation)

- Visually inspect the system for hydraulic leaks. If any leaks are found, retighten fittings.
- Change oil filters. This will ensure that any contamination that was flushed out in the start-up will not prematurely wear out your system.
- Torque rod clamp bolts and floor bolts. (See 4.3 Maintenance section for special values and instructions.) Loose rod clamp bolts and flooring bolts are the most common cause of severe damage to the drive or flooring. Any bolts that were loose should be checked weekly until found to be tight.

3.6 Pre-Trip Checklist

- ✓ Inspect drive unit for leaking fittings or hoses, and visible damage.
- ✓ Open truck or trailer doors and inspect flooring for damage. Inspect flooring at the rear of the truck for loose or bent slats that may have popped up.
- ✓ Operate the floor and inspect for leaks. Test the On/Off for proper operation. Test the load/unload for proper operation.
- ✓ If problems are found, report them to the maintenance shop as soon as possible.
- ✓ Secure truck or trailer doors and proceed.

As the driver, you will see damage or operational problems before anyone else. Please report issues and concerns as soon as possible.

 **WARNING:** Observations may be made while system is operating for troubleshooting purposes, but NEVER touch any moving part or attempt to make any adjustments to the system with the Power Take Off/Pumping system engaged or the *WALKING FLOOR*[®] unloader operating.

 **WARNING:** Do not attempt to make adjustments or repairs without consulting with a trained service technician from your company or KEITH (See 5.4 Technical Support section for contact information.)

3.7 Standard Operating Procedures

3.7.1 Manual Controls

⚠ DANGER: ALWAYS have doors fully open! NEVER, under any circumstances, engage the WALKING FLOOR® unloader with the doors of the truck/trailer closed. Catastrophic failure to the truck/trailer, as well as serious injury or death may occur.

⚠ DANGER: Use caution when opening doors. Material can become compacted against doors and they can open violently causing serious injury or death.

⚠ DANGER: NEVER allow anyone to stand or move through the area where the load is being discharged or go under truck/trailer body or enter truck/trailer while the system is operating. Burial, loss of limb or life may occur.

⚠ WARNING: While unloading, NEVER leave truck and trailer unattended.

1. Set parking brake on the truck/trailer and follow the Pre-Trip Check List.
2. Inspect hydraulic hoses and quick connects for contamination or damage (if applicable), then connect the floor to the truck wet kit.
3. If the load is covered with a tarp, remove and secure the tarp prior to engaging the floor.
4. Manually open truck/trailer rear door(s) fully and secure door(s) with provided chains or loop rings.
5. Twist the control valve knob (connected to the cartridge valve, see figure), in the required direction for the desired direction of material movement (Unload/Load) until it stops.
6. Set the On/Off Ball Valve handle (see figure) to the fully open (OFF) position. Floor will not operate! **NOTE:** The ball valve controls (On/Off) and is used as an emergency stop.
7. Engage PTO (Do NOT increase engine RPM's from idle). This allows hydraulic oil to start flowing through the pump and warming up before engaging the floor (ideally to 80 °F [27 °C]).
8. Fully open hydraulic cover and/or hydraulic rear truck/trailer door(s) (if equipped).
9. Set the On/Off Ball Valve handle (see figure above) to the fully closed (ON) position. The floor will start to operate!
10. Increase truck engine RPM's to predetermined setting to achieve desired flow rate from the wet kit.
11. When unloading, material will begin to pile up behind the truck/trailer. The load will stop moving when the pile of material gets too high. Reduce engine RPM's and move the truck/trailer forward (load will begin to move again). Repeat until the material is completely unloaded.
12. After loading/unloading is completed, reduce engine RPM's to idle and stop the floor with all slats in the forward position.
13. Fully retract CleanSweep® tarp (if equipped) to the front of the truck/trailer.
14. Close and secure the rear truck/trailer door(s).
15. Disengage PTO.

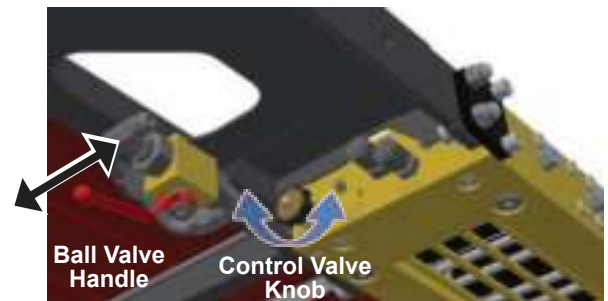

EMERGENCY STOP: In case of emergency the floor can be stopped in one of the following ways:

- Disengage the PTO.
- Fully open the ball valve.

3.7.2 Electric On/Off, Manual Load/Unload - Wireless Remote Control - Type I

3.7.2.1. 4 Channel Remote Control Transmitter

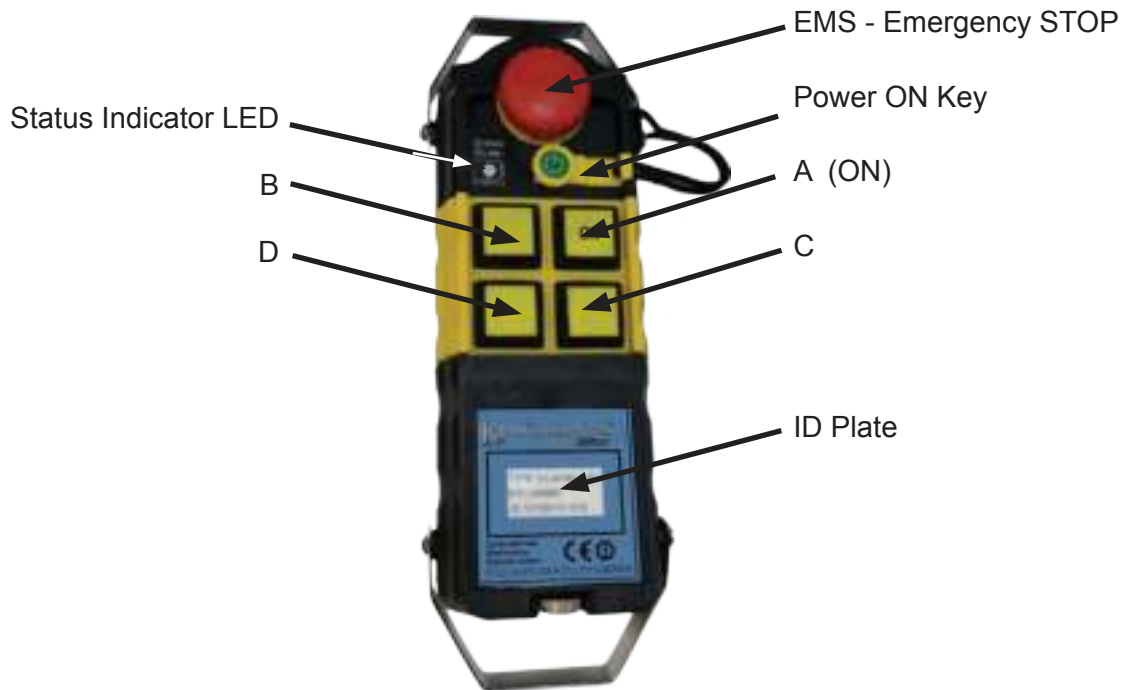

⚠ DANGER: ALWAYS have doors fully open! NEVER, under any circumstances, engage the *WALKING FLOOR*[®] unloader with the doors of the truck/trailer closed. Catastrophic failure to the truck/trailer, as well as serious injury or death may occur.

⚠ DANGER: Use caution when opening doors. Material can become compacted against doors and they can open violently causing serious injury or death.

⚠ DANGER: NEVER allow anyone to stand or move through the area where the load is being discharged or go under truck/trailer body or enter truck/trailer while the system is operating. Burial, loss of limb or life may occur.

⚠ WARNING: While unloading, NEVER leave truck and trailer unattended.

1. Set parking brake on the truck/trailer and follow the Pre-Trip Check List.
2. Inspect hydraulic hoses and quick connects for contamination or damage (if applicable), then connect the floor to the truck wet kit.
3. If the load is covered with a tarp, remove and secure the tarp prior to engaging the floor.
4. Manually open truck/trailer rear door(s) fully and secure door(s) with provided chains or loop rings.
5. Twist the control valve knob (See figure) in the required direction for the desired direction of material movement (Unload/Load).
6. Turn ON the remote receiver by twisting the EMS button clockwise to disengage the EMS (emergency stop) button. (The button will pop up.)
7. Engage PTO (Do NOT increase engine RPM's from idle). This allows hydraulic oil to start flowing through the pump and warming up before engaging the floor (ideally to 80 °F [27 °C]).
8. Fully open hydraulic cover and/or hydraulic rear truck/trailer door(s) (if equipped).
9. Turn ON the remote transmitter by twisting the EMS button clockwise to disengage the EMS.

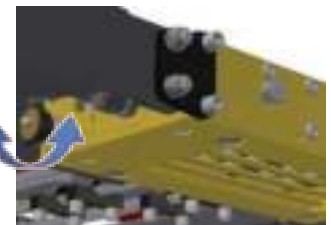

10. Insert the yellow power-on key into the transmitter. The status indicator LED will start blinking.

Transmitter Status Indicator:

Green: Battery power sufficient (Continue to next step)

Red: Battery power low. Requires 4x AA (1.5V) alkaline or nickel rechargeable batteries.
(May need to replace or recharge batteries before continuing.)

11. The remote transmitter is now ready for use.

ON - Maintained: Push and release the “ON” button on the remote transmitter. The floor will continue to move until the “ON” button is pressed again.

“B” - Momentary: Push and hold the “B” button on the remote transmitter. The floor will continue to move until the button is released.

12. Increase truck engine RPM's to predetermined setting to achieve desired flow rate from the wet kit.

13. When unloading, material will begin to pile up behind the truck/trailer. The load will stop moving when the pile of material gets too high. Reduce engine RPM's and move the truck/trailer forward (load will begin to move again). Repeat until the material is completely unloaded.

14. After loading/unloading is completed, reduce engine RPM's to idle and stop the floor with all slats in the forward position.

15. Fully retract KEITH® *WALKING FLOOR*® Sweep System (if equipped) to the front of the truck/trailer.

16. Close and secure the rear truck/trailer door(s).

17. Turn off the remote transmitter by pushing the EMS button and remove the yellow power-on key.

18. Turn off the receiver by pushing the EMS button.

19. Disengage PTO.

EMERGENCY STOP: In case of emergency the floor can be stopped in one of the following ways:

- Push the red EMS (emergency stop) button on the transmitter or receiver.
- Remove the yellow key from the transmitter.
- Disengage the PTO.
- Stop the electric power to the receiver.
- Manually push the On/Off valve off.

IMPORTANT NOTE: The KEITH wireless remote control has some built in features:

- The floor automatically stops moving if the continuous signal link, between receiver and transmitter, is not detected or out of range.
- The wireless remote control automatically turns off after 10 minutes if no buttons have been pressed. This will also cause the floor to stop moving.

3.7.2.2. 4 Channel Remote Control Receiver

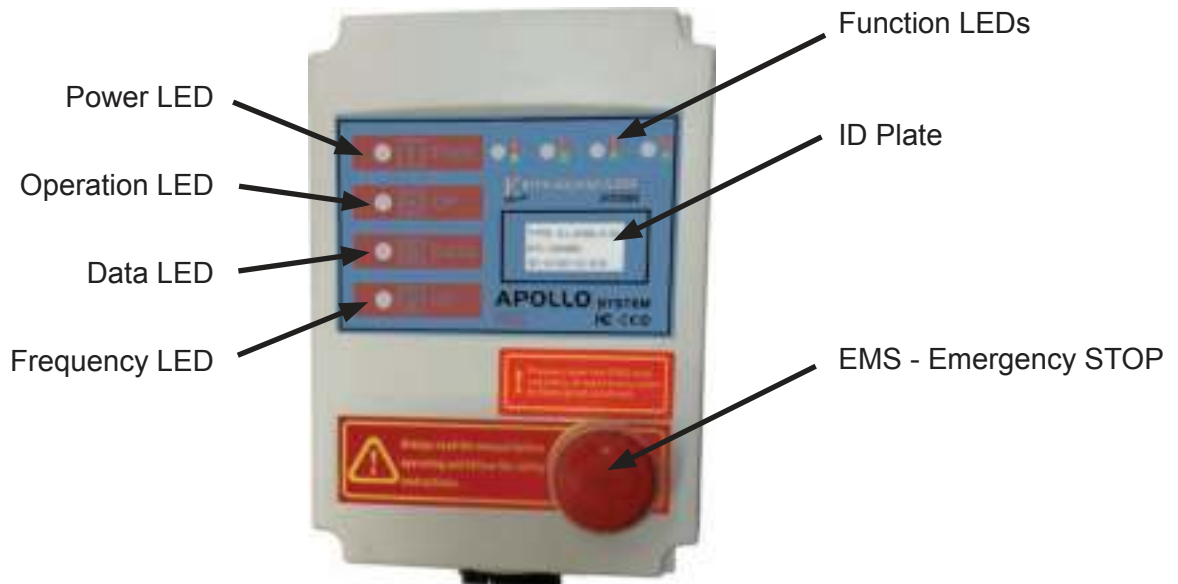

RECEIVER STATUS INDICATOR:

	<p>Power LED</p> <ul style="list-style-type: none"> • GREEN = Receiver power is ON
	<p>Operation LED</p> <ul style="list-style-type: none"> • GREEN = Both transmitter and receiver are ON • OFF = Transmitter power is OFF
	<p>Data LED</p> <ul style="list-style-type: none"> • OFF briefly = A button on the transmitter was pressed • RED = Transmitter OFF (EMS engaged and/or Power Key not inserted)) • RED blinking slowly = Normal continuous signal link • RED blinking irregularly = ID codes don't match
	<p>Frequency LED</p> <ul style="list-style-type: none"> • OFF = Normal state • RED = Blinking irregularly when interference incurred
	<p>Function LEDs</p> <ul style="list-style-type: none"> • ON = Solid RED light "A" until pressed again or until "B" is pressed • B = RED "A" and GREEN "B" both light while button is pressed • C = RED "C" light while button is pressed • D = GREEN "D" light while button is pressed

3.7.3 Electric On/Off & Electric Load/Unload - Wireless Remote Control - Type I

3.7.3.1. 4 Channel Remote Control Transmitter

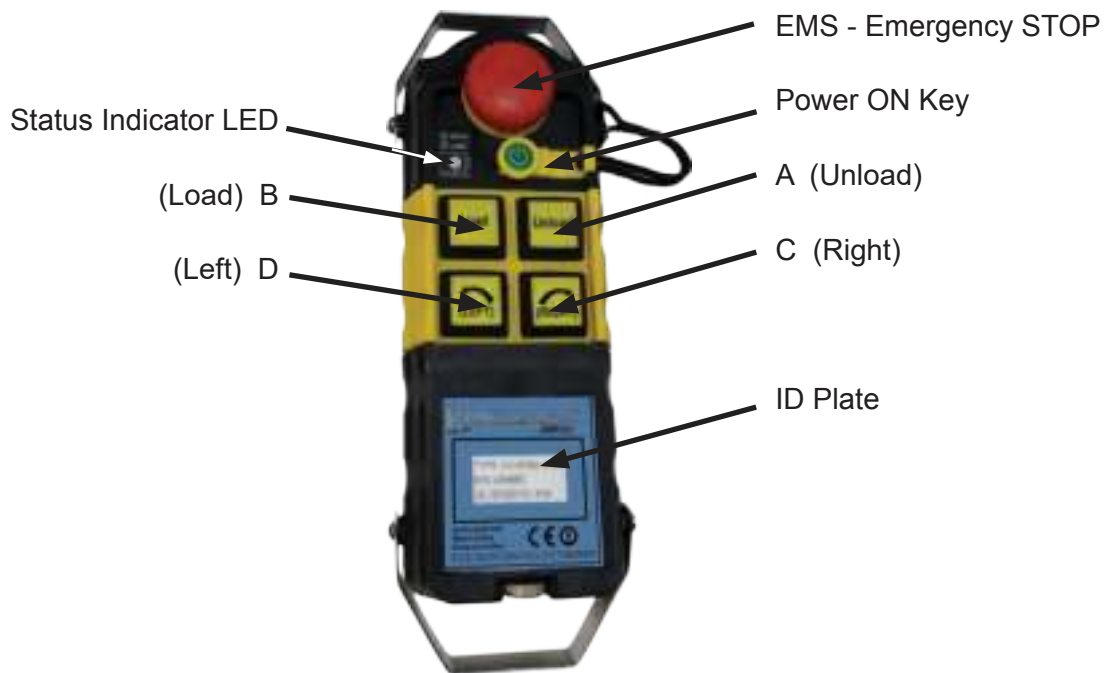

⚠ DANGER: ALWAYS have doors fully open! NEVER, under any circumstances, engage the *WALKING FLOOR*[®] unloader with the doors of the truck/trailer closed. Catastrophic failure to the truck/trailer, as well as serious injury or death may occur.

⚠ DANGER: Use caution when opening doors. Material can become compacted against doors and they can open violently causing serious injury or death.

⚠ DANGER: NEVER allow anyone to stand or move through the area where the load is being discharged or go under truck/trailer body or enter truck/trailer while the system is operating. Burial, loss of limb or life may occur.

⚠ WARNING: While unloading, NEVER leave truck and trailer unattended.

1. Set parking brake on the truck/trailer and follow the Pre-Trip Check List.
2. Inspect hydraulic hoses and quick connects for contamination or damage (if applicable), then connect the floor to the truck wet kit.
3. If the load is covered with a tarp, remove and secure the tarp prior to engaging the floor.
4. Manually open truck/trailer rear door(s) fully and secure door(s) with provided chains or loop rings.
5. Turn ON the remote receiver by twisting the EMS button clockwise to disengage the EMS (emergency stop) button. (The button will pop up.)
6. Engage PTO (Do NOT increase engine RPM's from idle). This allows hydraulic oil to start flowing through the pump and warming up before engaging the floor (ideally to 80 °F [27 °C]).
7. Fully open hydraulic cover and/or hydraulic rear truck/trailer door(s) (if equipped).
8. Turn ON the remote transmitter by twisting the EMS button clockwise to disengage the EMS.

9. Insert the yellow power-on key into the transmitter. The status indicator LED will start blinking.

Transmitter Status Indicator:

Green: Battery power sufficient (Continue to next step)

Red: Battery power low. Requires 4x AA (1.5V) alkaline or nickel rechargeable batteries.
(May need to replace or recharge batteries before continuing.)

10. The remote transmitter is now ready for use.

UNLOAD - Maintained: Push and release “UNLOAD” button on remote transmitter.

Floor will continue to move until “UNLOAD” button is pressed again.

LOAD - Momentary: Push and hold the “LOAD” button.

Floor will continue to move until button is released.

LEFT / RIGHT:

These buttons can be used for other functions, for example retracting a KEITH® *WALKING FLOOR*® Sweep System. Pushing and holding one of these buttons activates the function until the button is released.

11. Increase truck engine RPM's to predetermined setting to achieve desired flow rate from the wet kit.
12. When unloading, material will begin to pile up behind the truck/trailer. The load will stop moving when the pile of material gets too high. Reduce engine RPM's and move the truck/trailer forward (load will begin to move again). Repeat until the material is completely unloaded.
13. After loading/unloading is completed, reduce engine RPM's to idle and stop the floor with all slats in the forward position.
14. Fully retract KEITH® *WALKING FLOOR*® Sweep System (if equipped) to the front of the truck/trailer.
15. Close and secure the rear truck/trailer door(s).
16. Turn off the remote transmitter by pushing the EMS button and remove the yellow power-on key.
17. Turn off the receiver by pushing the EMS button.
18. Disengage PTO.

EMERGENCY STOP: In case of emergency the floor can be stopped in one of the following ways:

- Push the red EMS (emergency stop) button on the transmitter or receiver.
- Remove the yellow key from the transmitter.
- Disengage the PTO / Pumping System.
- Stop the electric power to the receiver.
- Manually push the On/Off valve off.

IMPORTANT NOTE: The KEITH wireless remote control has some built in features:

- The floor automatically stops moving if the continuous signal link, between receiver and transmitter, is not detected.
- The wireless remote control automatically turns off after 10 minutes if no buttons have been pressed. This will also cause the floor to stop moving.

3.7.3.2. 4 Channel Remote Control Receiver

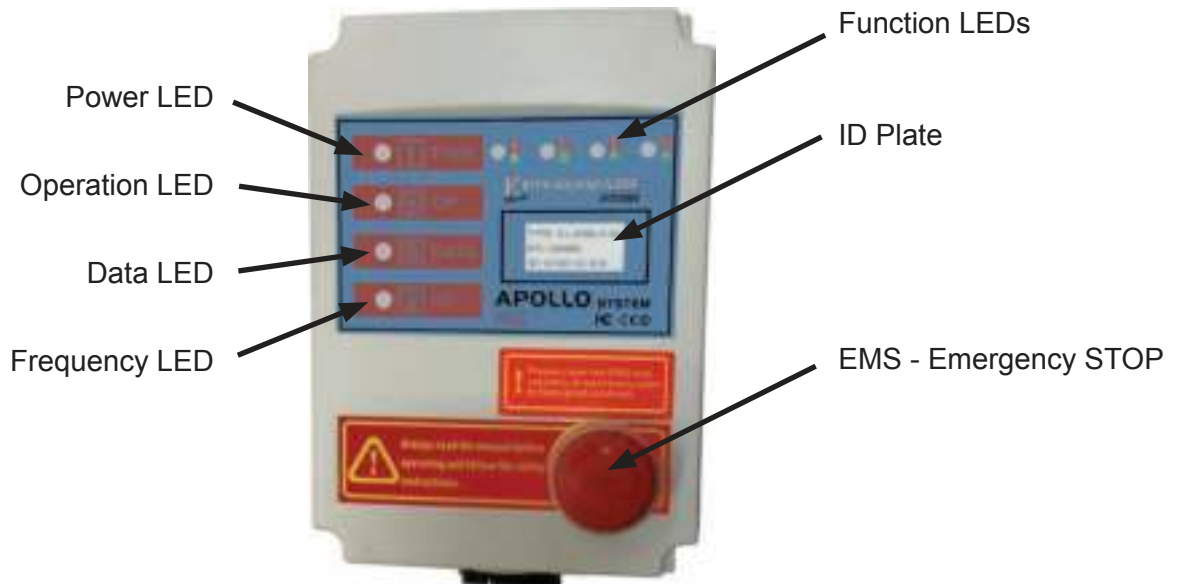

RECEIVER STATUS INDICATOR:

	<p>Power LED</p> <ul style="list-style-type: none"> • GREEN = Receiver power is ON
	<p>Operation LED</p> <ul style="list-style-type: none"> • GREEN = Both transmitter and receiver are ON • OFF = Transmitter power is OFF
	<p>Data LED</p> <ul style="list-style-type: none"> • OFF briefly = A button on the transmitter was pressed • RED = Transmitter OFF (EMS engaged and/or Power Key not inserted)) • RED blinking slowly = Normal continuous signal link • RED blinking irregularly = ID codes don't match
	<p>Frequency LED</p> <ul style="list-style-type: none"> • OFF = Normal state • RED = Blinking irregularly when interference incurred
	<p>Function LEDs</p> <ul style="list-style-type: none"> • UNLOAD = Solid RED light "A" until any button is pressed • LOAD = RED "A" and GREEN "B" both light while button is pressed • RIGHT = RED "C" light while button is pressed • LEFT = GREEN "D" light while button is pressed

3.7.4 Electric On/Off & Electric Load/Unload - Wireless Remote Control - Type II

3.7.4.1. 4 Channel Remote Control Transmitter



⚠ DANGER: ALWAYS have doors fully open! NEVER, under any circumstances, engage the *WALKING FLOOR*[®] unloader with the doors of the truck/trailer closed. Catastrophic failure to the truck/trailer, as well as serious injury or death may occur.

⚠ DANGER: Use caution when opening doors. Material can become compacted against doors and they can open violently causing serious injury or death.

⚠ DANGER: NEVER allow anyone to stand or move through the area where the load is being discharged or go under truck/trailer body or enter truck/trailer while the system is operating. Burial, loss of limb or life may occur.

⚠ WARNING: While unloading, NEVER leave truck and trailer unattended.

1. Set parking brake on the truck/trailer and follow the Pre-Trip Check List.
2. Inspect hydraulic hoses and quick connects for contamination or damage (if applicable), then connect the floor to the truck wet kit.
3. If the load is covered with a tarp, remove and secure the tarp prior to engaging the floor.
4. Manually open truck/trailer rear door(s) fully and secure door(s) with provided chains or loop rings.
5. Engage PTO (Do NOT increase engine RPM's from idle). This allows hydraulic oil to start flowing through the pump and warming up before engaging the floor (ideally to 27 °C [80 °F]).
6. Fully open hydraulic cover and/or hydraulic rear truck/trailer door(s) (if equipped).
7. Turn ON the transmitter using the power switch on the back of the transmitter from O to I.
8. Wake up the transmitter by pressing and holding both A & B (Load & Unload) buttons for 2 seconds, then release. The center LED light will blink when it is awake and be solid when it's transmitting:

Transmitter Status Indicator:

Green: Battery power sufficient (Continue to next step)



Red: Battery power low. Requires 3x AAA (1.5V) Alkaline batteries.
(May need to replace or recharge batteries before continuing.)

9. The transmitter is now ready for use.

UNLOAD - Maintained: Push and release “UNLOAD” button on transmitter. Floor will continue to move until the “UNLOAD” button is pressed again.

LOAD - Momentary: Push and hold the “LOAD” button on the transmitter. Floor will continue to move until the button is released.

IN/OPEN – OUT/CLOSE - Momentary: These buttons can be used for other functions, for example retracting a KEITH[®] *WALKING FLOOR*[®] Sweep System. Pushing and holding one of these buttons activates the function until the button is released.

10. Increase truck engine RPM's to predetermined setting to achieve desired flow rate from the wet kit.
11. When unloading, material will begin to pile up behind the truck/trailer. The load will stop moving when the pile of material gets too high. Reduce engine RPM's and move the truck/trailer forward (load will begin to move again). Repeat until the material is completely unloaded.
12. After loading/unloading is completed, reduce engine RPM's to idle and stop the floor with all slats in the forward position.
13. Fully retract KEITH[®] *WALKING FLOOR*[®] Sweep System (if equipped) to the front of the truck/trailer.
14. Close and secure the rear truck/trailer door(s).
15. Turn off the transmitter using the power switch on the back of the transmitter from I to O.
16. Disengage PTO.

EMERGENCY STOP: In case of emergency the floor can be stopped in one of the following ways:

- Turn OFF the switch on the back of the transmitter from I to O
- Disengage the PTO
- Stop the electric power to the receiver.
- Manually push the On/Off valve off.

IMPORTANT NOTE: The KEITH wireless remote control has some built in features:

- The floor automatically stops moving if the continuous signal link, between receiver and transmitter, is not detected.
- The wireless remote control automatically turns off after 10 minutes if no buttons have been pressed. This will also cause the floor to stop moving.

3.7.4.2. 4 Channel Remote Control Receiver

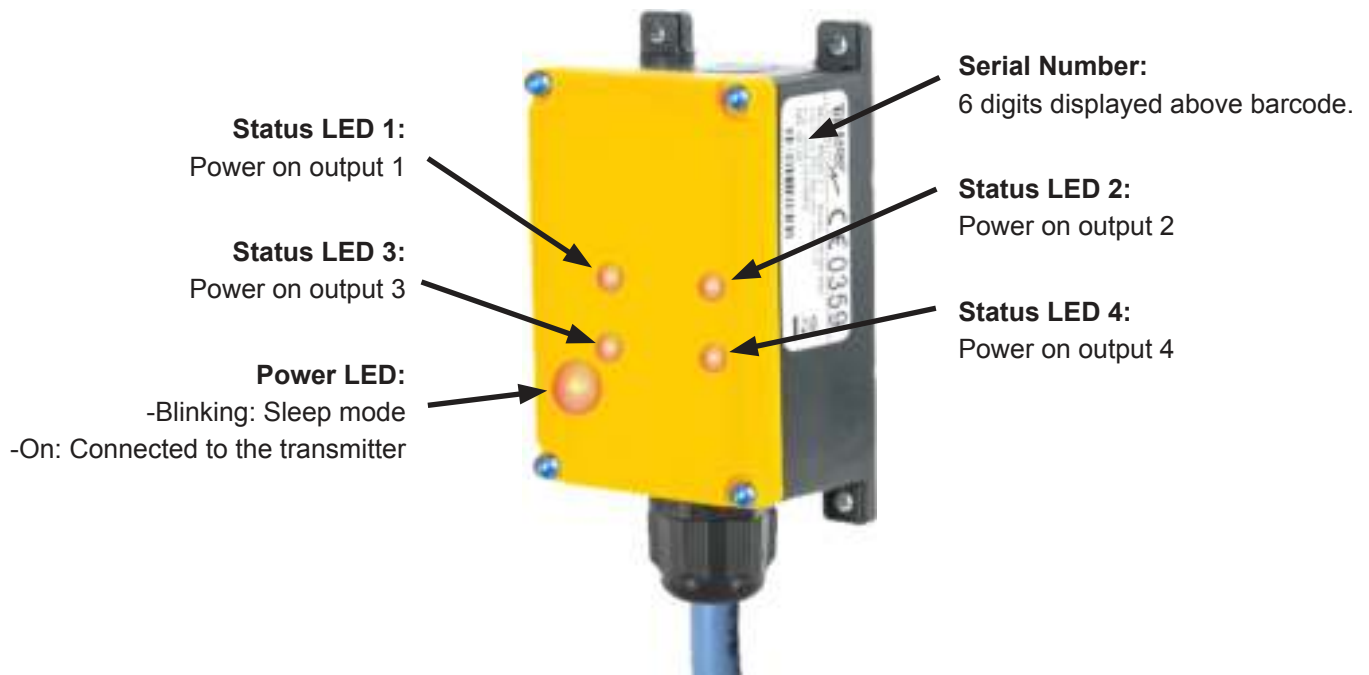

LEDs are not visible, but the light shines through the yellow cover.

3.7.5 Electric On/Off & Electric Load/Unload - Cabled Pendant - Type I

⚠ DANGER: ALWAYS have doors fully open! NEVER, under any circumstances, engage the *WALKING FLOOR*[®] unloader with the doors of the truck/trailer closed. Catastrophic failure to the truck/trailer, as well as serious injury or death may occur.

⚠ DANGER: Use caution when opening doors. Material can become compacted against doors and they can open violently causing serious injury or death.

⚠ DANGER: NEVER allow anyone to stand or move through the area where the load is being discharged or go under truck/trailer body or enter truck/trailer while the system is operating. Burial, loss of limb or life may occur.

⚠ WARNING: While unloading, NEVER leave truck and trailer unattended.

1. Set parking brake on the truck/trailer and follow the Pre-Trip Check List.
2. Inspect hydraulic hoses and quick connects for contamination or damage (if applicable), then connect the floor to the truck wet kit.
3. If the load is covered with a tarp, remove and secure the tarp prior to engaging the floor.
4. Manually open truck/trailer rear door(s) fully and secure door(s) with provided chains or loop rings.
5. Engage PTO (Do NOT increase engine RPM's from idle). This allows hydraulic oil to start flowing through the pump and warming up before engaging the floor (ideally to 80 °F [27 °C]).
6. Fully open hydraulic cover and/or hydraulic rear truck/trailer door(s) (if equipped).
7. Turn on the electric power to operate the pendant (if applicable).
8. Turn ON the remote by twisting the EMS button clockwise to disengage the EMS (emergency stop) button. (The button will pop up.)
9. Now the remote control is ready for use.

UNLOAD - Maintained: Push and release the top of the rocker switch on the control. Floor will continue to move until any button is pushed.

LOAD - Momentary: Push and hold the bottom of the rocker switch on the control. Floor will continue move until the switch is released.

10. Increase truck engine RPM's to predetermined setting to achieve desired flow rate from the wet kit.
11. When unloading, material will begin to pile up behind the truck/trailer. The load will stop moving when the pile of material gets too high. Reduce engine RPM's and move the truck/trailer forward (load will begin to move again). Repeat until the material is completely unloaded.
12. After loading/unloading is completed, reduce engine RPM's to idle and stop the floor with all slats in the forward position.
13. Fully retract KEITH[®] *WALKING FLOOR*[®] Sweep System (if equipped) to the truck/trailer.
14. Close and secure the rear truck/trailer door(s).
15. Turn off the remote control by pushing the EMS button.
16. Turn off the electric power to the pendant (if applicable).
17. Disengage PTO.

EMERGENCY STOP: In case of emergency the floor can be stopped in one of the following ways:

- Push the red EMS (emergency stop) button on the remote
- Disengage the PTO / Pumping System.
- Manually push the On/Off valve off.

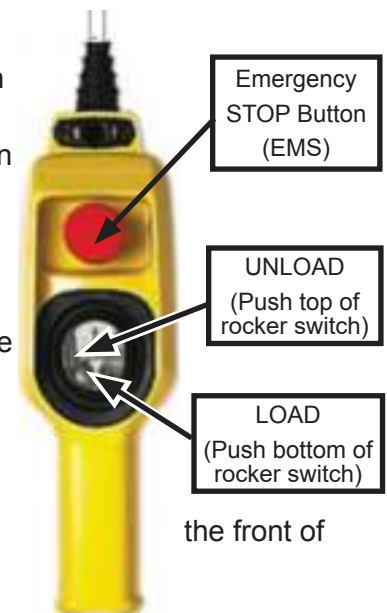

3.7.6 Electric On/Off & Electric Load/Unload - Cabled Pendant - Type II

⚠ DANGER: ALWAYS have doors fully open! NEVER, under any circumstances, engage the *WALKING FLOOR*® unloader with the doors of the truck/trailer closed. Catastrophic failure to the truck/trailer, as well as serious injury or death may occur.

⚠ DANGER: Use caution when opening doors. Material can become compacted against doors and they can open violently causing serious injury or death.

⚠ DANGER: NEVER allow anyone to stand or move through the area where the load is being discharged or go under truck/trailer body or enter truck/trailer while the system is operating. Burial, loss of limb or life may occur.

⚠ WARNING: While unloading, NEVER leave truck and trailer unattended.

1. Set parking brake on the truck/trailer and follow the Pre-Trip Check List.
2. Inspect hydraulic hoses and quick connects for contamination or damage (if applicable), then connect the floor to the truck wet kit.
3. If the load is covered with a tarp, remove and secure the tarp prior to engaging the floor.
4. Manually open truck/trailer rear door(s) fully and secure door(s) with provided chains or loop rings.
5. Engage PTO (Do NOT increase engine RPM's from idle). This allows hydraulic oil to start flowing through the pump and warming up before engaging the floor (ideally to 27 °C [80 °F]).
6. Fully open hydraulic cover and/or hydraulic rear truck/trailer door(s) (if equipped).
7. Plug the pendant into the socket on the control box.
8. Turn on the electric power to operate the pendant (if applicable).
9. Turn ON the remote by twisting the EMS button clockwise to disengage the EMS (emergency stop) button. (The button will pop up.)
10. Now the remote control is ready for use.

UNLOAD - Maintained: Turn the black switch on the control to the right and release. Floor will continue to move until the black switch is returned to the middle position or the EMS button is pushed.

LOAD - Momentary: Turn the black switch on the control to the left and hold. Floor will continue to move until the switch is released.

11. Increase truck engine RPM's to predetermined setting to achieve desired flow rate from the wet kit.
12. When unloading, material will begin to pile up behind the truck/trailer. The load will stop moving when the pile of material gets too high. Reduce engine RPM's and move the truck/trailer forward (load will begin to move again). Repeat until the material is completely unloaded.
13. After loading/unloading is completed, reduce engine RPM's to idle and stop the floor with all slats in the forward position.
14. Fully retract KEITH® *WALKING FLOOR*® Sweep System (if equipped) to the front of the truck/trailer.
15. Close and secure the rear truck/trailer door(s).
16. Turn off the electric power to the pendant by pushing the EMS button.
17. Unplug the pendant from the socket on the control box.
18. Disengage PTO.

EMERGENCY STOP: In case of emergency the floor can be stopped in one of the following ways:

- Push the red EMS (emergency stop) button on the pendant
- Disengage the PTO / Pumping System.
- Manually push the On/Off valve off.



3.7.7 Manual Override of Electric Controls (if equipped)

⚠ DANGER: ALWAYS have doors fully open! NEVER, under any circumstances, engage the *WALKING FLOOR*® unloader with the doors of the truck/trailer closed. Catastrophic failure to the truck/trailer, as well as serious injury or death may occur.

⚠ DANGER: Use caution when opening doors. Material can become compacted against doors and they can open violently causing serious injury or death.

⚠ DANGER: NEVER allow anyone to stand or move through the area where the load is being discharged or go under truck/trailer body or enter truck/trailer while the system is operating. Burial, loss of limb or life may occur.

⚠ WARNING: While unloading, NEVER leave truck and trailer unattended.

In the case of a malfunction in the electrical system or loss of the remote control, electric valves can still be operated by activating the manual override fitted for that purpose.

1. Set parking brake on the truck/trailer and follow the Pre-Trip Check List.
2. Inspect hydraulic hoses and quick connects for contamination or damage (if applicable), then connect the floor to the truck wet kit.
3. If the load is covered with a tarp, remove and secure the tarp prior to engaging the floor.
4. Manually open truck/trailer rear door(s) fully and secure door(s) with provided chains or loop rings
5. (See figure below). Determine if the floor is in the load or unload mode. If the floor is not in the desired mode: (1) Push the red button in and (2) turn it half a turn. (3) Release the red button.
NOTE: After using the system, return the red solenoid button to the default position.

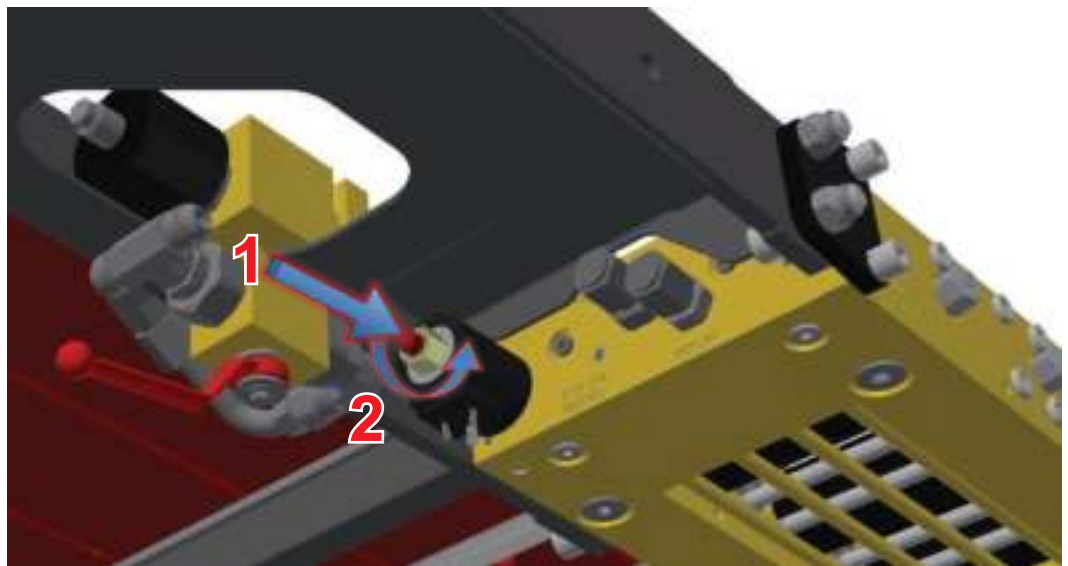

Manual Override - Control Valve (solenoid)

6500001

Red Button

CW In = Unload (Default)

CCW Out = Load

6. Set the On/Off Ball Valve handle (see figure below) to the fully open (OFF) position. Floor will not operate. **NOTE:** The ball valve controls (On/Off) and is used as an emergency stop.

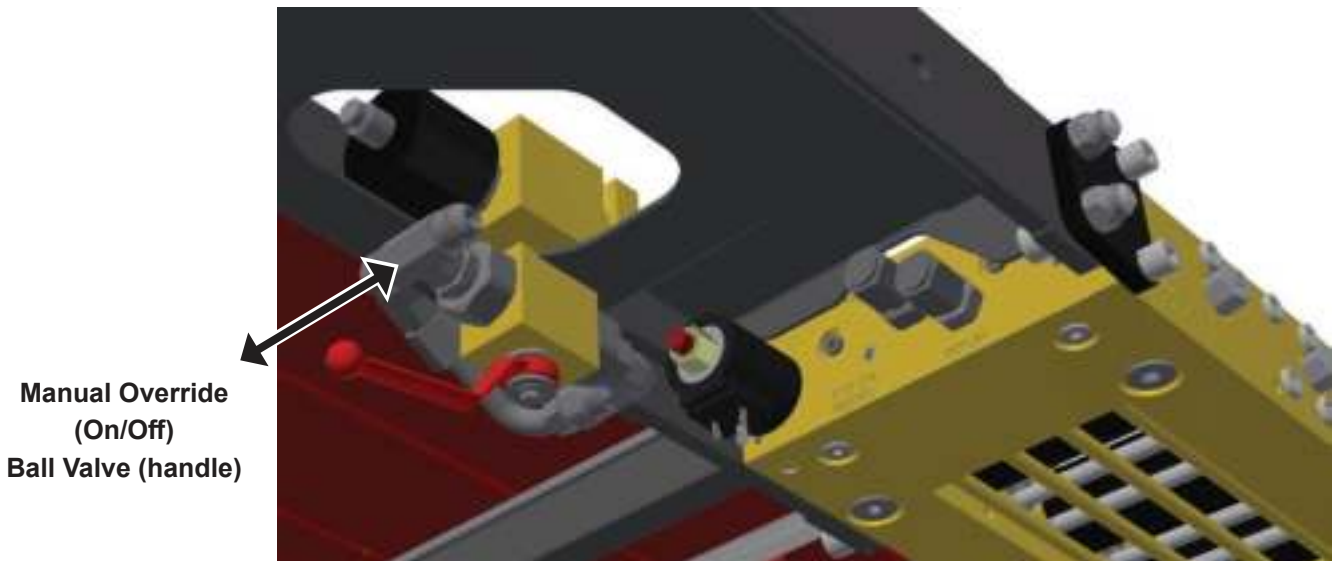

Manual Override
(On/Off)
Ball Valve (handle)

6500001

7. Engage PTO (Do NOT increase engine RPM's from idle). This allows hydraulic oil to start flowing through the pump and warming up before engaging the floor (ideally to 80 °F [27 °C]).
8. Fully open hydraulic cover and/or hydraulic rear truck/trailer door(s) (if equipped).
9. Set the On/Off Ball Valve handle (see figure above) to the fully closed (ON) position. The floor will start to operate!
10. Increase truck engine RPM's to predetermined setting to achieve desired flow rate from the wet kit.
11. When unloading, material will begin to pile up behind the truck/trailer. The load will stop moving when the pile of material gets too high. Reduce engine RPM's and move the truck/trailer forward (load will begin to move again). Repeat until the material is completely unloaded.
12. After loading/unloading is completed, reduce engine RPM's to idle and stop the floor with all slats in the forward position.
13. Fully retract KEITH® WALKING FLOOR® Sweep System (if equipped) to the front of the truck/trailer.
14. Close and secure the rear truck/trailer door(s).
15. Disengage PTO

4.0 Maintenance

 **DANGER:** The extreme forces exerted by the floor, when in operation, can result in damage to equipment, as well as cause serious injury or death. Always follow lockout/tagout procedures. Switch off the Power Take Off (PTO) and manually push/turn the ball valve to the fully open position during maintenance and/or service work.

4.1 Life Extending Practices

- Follow the Start-Up procedures in this manual.
- Use only clean oil, free from contamination.
- Regularly inspect the system for loose bolts. Loose rod clamp bolts and flooring bolts are the most common cause of severe damage to the drive or flooring.
- Be aware of the pressures your system typically runs at (with and without loads). Increased pressure can indicate potential problems.

4.2 Preventative Maintenance

4.2.1 Monthly Service (25 operating hours)

- Check the system for hydraulic leaks.
- Check the operating temperature. No single component should be warmer than 140 °F [60 °C] while the system is running.
- Torque rod clamp bolts and floor bolts. (See 4.3 Maintenance section for special values and instructions.) Any bolts that were loose should be checked weekly until found to be tight.
- Pressure wash drive unit, sub-deck, and slats (recommended quarterly, minimum twice per year).

4.2.2 6-Month Service (150 operating hours)

- Change the oil filters.
- Cycle the system briefly in both directions and observe to ensure proper operation. Do NOT allow material to compact against the front of the trailer or against the rear doors.
- Inspect cross-drive support bearings, wearpads, tubes and shoes for wear. (See 4.4 Cross-Drive Wear Component Diagram section). Replace as needed.
- Inspect floor wear bearings and seals for excessive wear (especially above the tires). (See 4.5 Flooring Wear Component Diagrams section) Replace as needed.
- Inspect floor slats for wear. If discharge end of slats are worn down more than 75% of original material thickness rotate all floor slats, end for end, to increase life of the floor. If floor has already been rotated, contact KEITH for replacement slats.

4.3 Bolt Torque Requirements

Description	Size	Qty	Torque Values
Bearing Block Bolts	M12 CL12.9 SHCS	6	Snug ** (Do Not Overtighten)
* Rod Clamp Bolts (Requires blue Loctite 243)	M12 CL12.9 SHCS	4 per Rod	83 ft.-lbs. [113 N·m]
* Cylinder Pack Bolts (Requires blue Loctite 243)	M12 CL12.9 SHCS	10	83 ft.-lbs. [113 N·m]
* Cylinder Pack Bolts (Requires blue Loctite 243)	M10 CL12.9 SHCS	4	45 ft-lbs [61 N·m]
* Floor Bolts (Flat Head) (Requires blue Loctite 243)	M10 CL10.9 FHCS (90°)	Varies	32 ft-lbs [43 N·m]

* Bolts installed using thread lock should be checked using a setting that is 5 ft-lbs [7 Nm] less than the above specified value. If the bolt moves then you should remove it, clean it, apply new loctite to the threads and torque it to the full specified value.

** Over tightening the bearing block bolts can deform the bearing causing the rods to bind and not function properly.

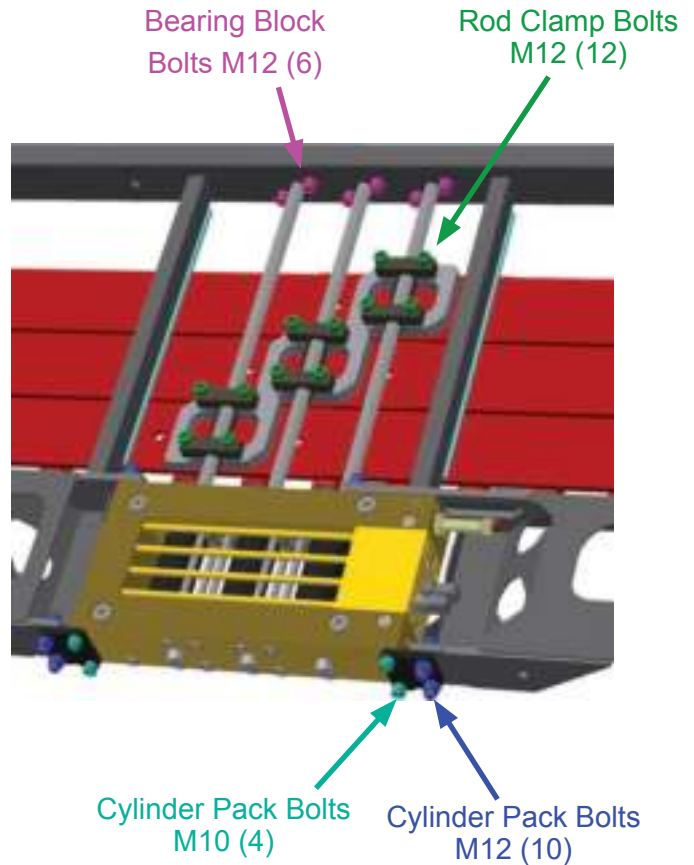
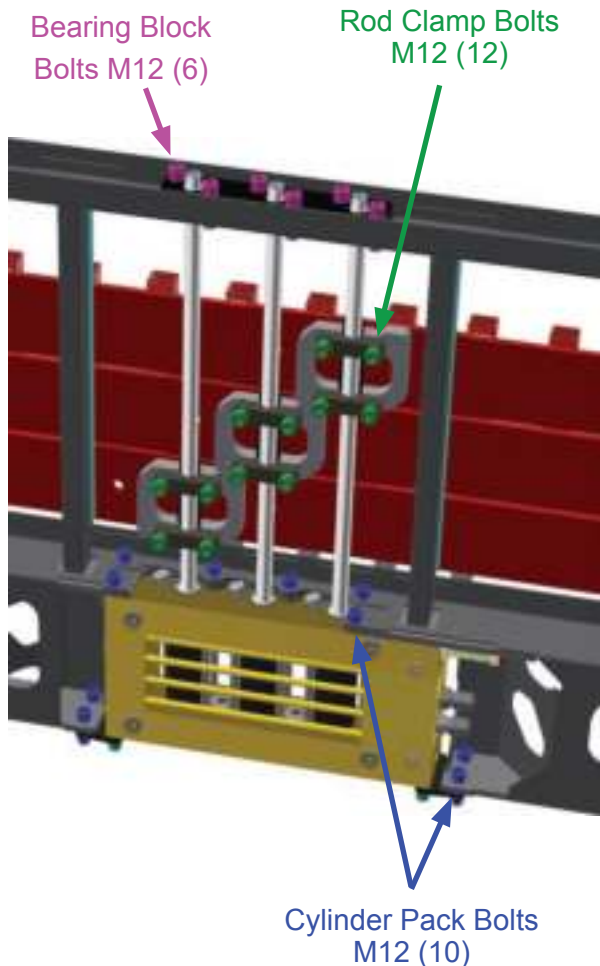

4.4 Cross-Drive Wear Component Diagram

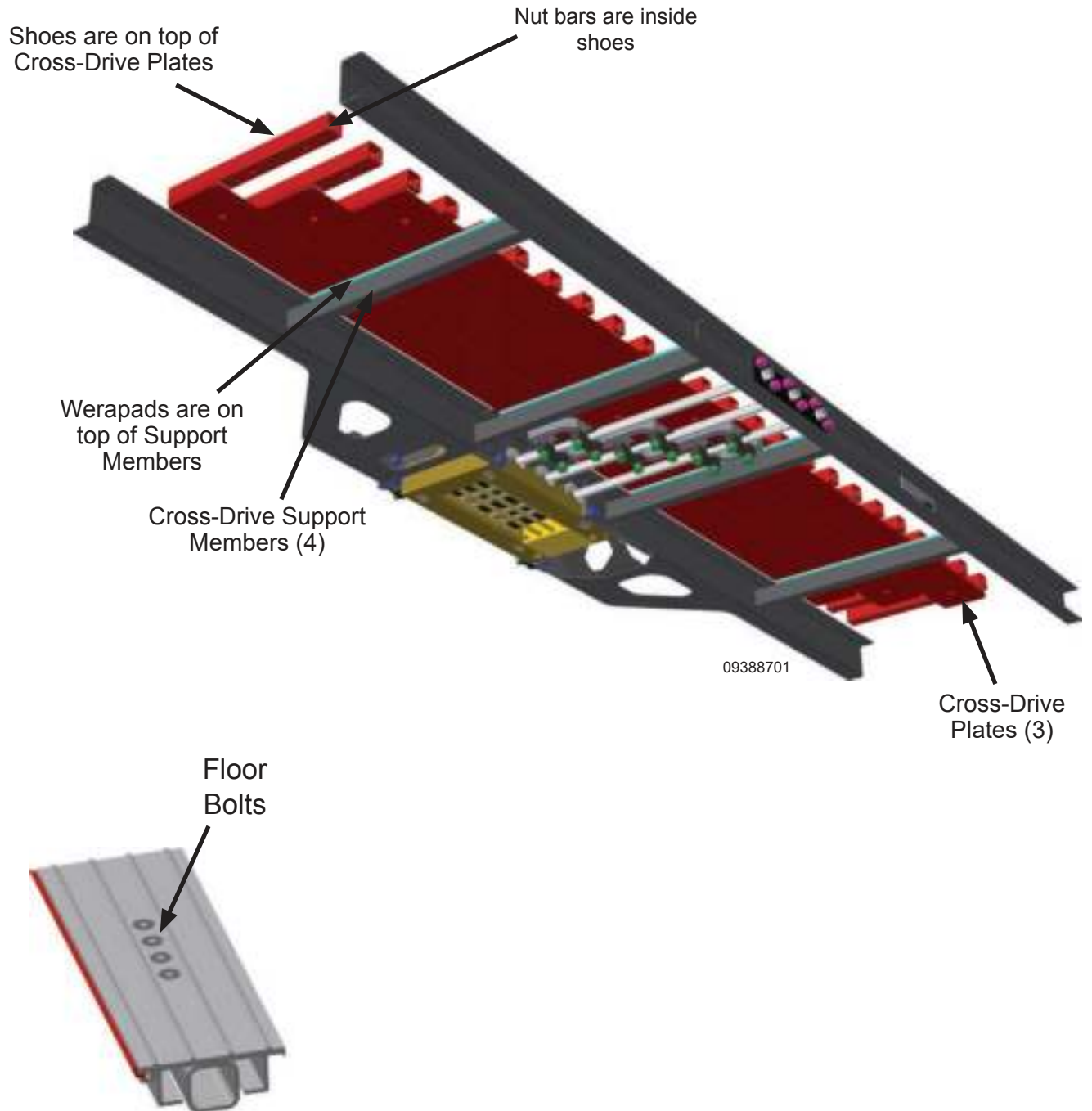

4.5 Flooring Wear Component Diagrams

Floor Wear Bearings & Seals *

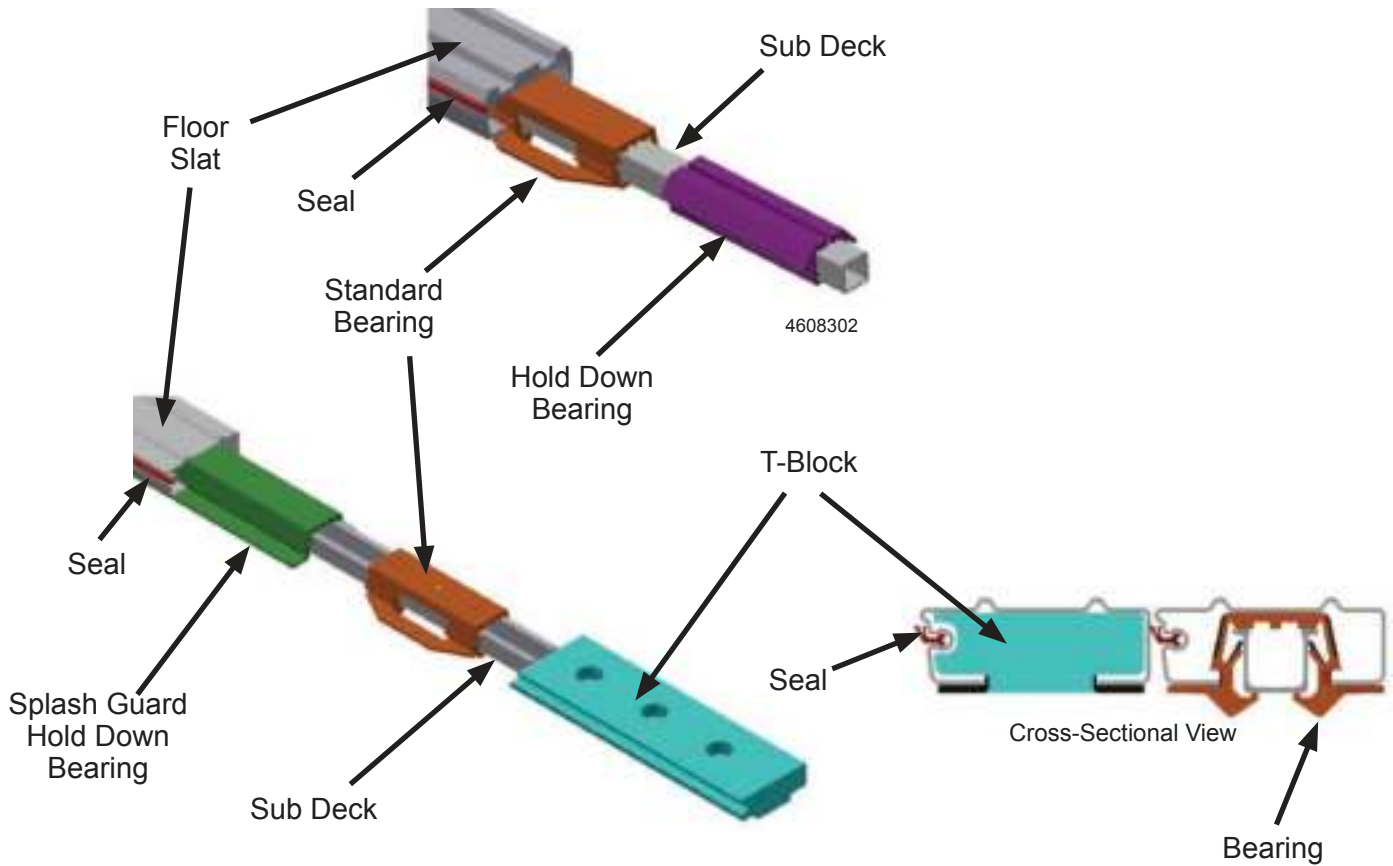

* These images are for illustrative purposes with colors modified for clarity.
 Style and quantity of wear bearings & seals varies by design.
 Wear bearings & seals are non-metallic and run the length of the floor.
 (They are designed to be replaced to extend the life of the floor.)

10005601

5.0 Troubleshooting

5.1 Check List

Before contacting KEITH for technical assistance please verify the following:

- ✓ Wet Kit: Does your entire wet kit system meet the requirements in the 2.2 Specifications section in this manual? (Additional Wet Kit information is available on our website.)
- ✓ Pump: Does it meet minimum requirements in 2.2 Specifications Section?
- ✓ Relief Valve: Is it set per the requirements in the 2.2 Specifications Section?
- ✓ Oil: Is the oil reservoir full?
- ✓ Power Take Off: Is the PTO engaged?
- ✓ Ball Valve: Is the manual ball valve (if equipped), that engages the drive unit (On/Off), fully closed?
- ✓ Control Valve: Is the control valve fully engaged in the appropriate position (Load/Unload)?
- ✓ Electrical Operation: Is there sufficient voltage? Is the Emergency Stop button disengaged?

5.2 Problem / Solution - Troubleshooting

Problem:	The cycle begins, then the floor stops.
<i>Specific Problem:</i>	All cylinders stop at one end or the other.
<i>Possible Cause:</i>	Insufficient pressure.
<i>Solution:</i>	Check the pressure and adjust the pressure relief valve, if necessary. If the floor stops in the full rear position and the switching valve has switched, the oil pressure may not be high enough. Less pressure is required to move the load than to pull the slats individually (1/3 at a time) under the load.
<i>Specific Problem:</i>	All cylinders move toward the rear of the vehicle, then the system stops.
<i>Possible Cause #1:</i>	The switching valve is not switching correctly.
<i>Solution:</i>	Contact Keith Manufacturing Co. Service Department.
<i>Specific Problem:</i>	The floor functions perfectly without a load or with a light load, but not with a heavy load.
<i>Possible Cause #1:</i>	Insufficient pressure.
<i>Solution:</i>	Check the pressure and adjust the pressure relief valve, if necessary.

<i>Possible Cause #2:</i>	The switching valve is not switching correctly.
<i>Solution:</i>	Check the adjustment of the nuts on the threaded actuator rod as detailed above.
Problem:	Drive cycles incorrectly when unloading.
<i>Specific Problem:</i>	Cylinders #1 and #2 extend together toward the front of the vehicle.
<i>Possible Cause:</i>	The check valve at the front end of cylinder #1 has malfunctioned.
<i>Solution:</i>	Replace the check valve.
<i>Specific Problem:</i>	Cylinders #2 and #3 extend together toward the front of the vehicle.
<i>Possible Cause:</i>	The check valve at the front end of cylinder #2 has malfunctioned.
<i>Solution:</i>	Replace the check valve.
<i>Specific Problem:</i>	All cylinders extend together toward the front of the vehicle.
<i>Possible Cause #1:</i>	The load/unload cartridge valve has malfunctioned.
<i>Solution:</i>	Replace the load/unload cartridge valve.
<i>Possible Cause #2:</i>	The check valves at the front end of cylinders #1 and #2 have malfunctioned.
<i>Solution:</i>	Replace the check valves.
Problem:	Drive cycles incorrectly when loading.
<i>Specific Problem:</i>	Cylinders #2 and #3 extend together toward the rear of the vehicle.
<i>Possible Cause:</i>	The check valve at the rear end of cylinder #3 has malfunctioned.
<i>Solution:</i>	Replace the check valve.
<i>Specific Problem:</i>	Cylinders #1 and #2 extend together toward the rear of the vehicle.
<i>Possible Cause:</i>	The check valve at the rear end of cylinder #2 has malfunctioned.
<i>Solution:</i>	Replace the check valve.
<i>Specific Problem:</i>	All cylinders extend together to the rear of the vehicle.
<i>Possible Cause #1:</i>	The load/unload cartridge valve has malfunctioned.
<i>Solution:</i>	Replace the load/unload cartridge valve.
<i>Possible Cause #2:</i>	The check valves at the front end of cylinders #2 and #3 have malfunctioned.
<i>Solution:</i>	Replace the check valves.

5.3 Adjustments & Repairs

5.3.1 Check Valve Replacement

Replacing a KEITH® System check valve is a simple procedure.

The tools required to do this are:

- (1) 11/16" [18 mm] x 3/8" [10 mm] drive socket
- (1) 3/8" [10 mm] drive ratchet
- (1) Small magnet
- (1) Flash light
- (1) Bucket & shop towels

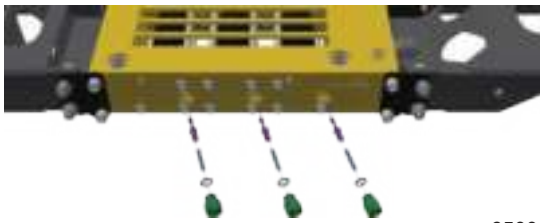

6500001



NOTE: The check valves at the rear of the cylinders (discharge end) do nothing when you are unloading and are used for loading only.

5.3.1.1. Check Valve Removal

1. Run the cylinder away from the check valve in order to free it.
2. Place the bucket under the check valve to be removed.
3. Clean the area with a shop towel.
4. Remove the check valve with the 11/16" [18 mm] socket and ratchet.
5. Use the magnet to remove the spring and check valve.
6. Inspect the valve seat for damage. Use the flash light as necessary.

5.3.1.2. Check Valve Installation

1. Ensure all of the surfaces are clean.
2. Place the supplied O-Ring on the check valve cap, if necessary.
3. Insert the check valve and place the spring on the check valve stem.
4. Place the check valve cap over the spring and carefully thread it into the manifold body. Be careful not to cross thread, which will cause the manifold to permanently leak.
5. Tighten the cap. **DO NOT OVER TIGHTEN!**
6. Run the floor and check for leaks.

5.3.2 Cylinder Pack Replacement

Cylinder Pack Removal

Step #4 (Optional)

The rod end bearing block can be left in place while replacing the cylinder pack, but can be loosened or removed to make things easier. Remove (6) M12 bolts & lock nuts, rod bearing block and cover plate.

Requires:

- (1) 1/2" [12.5 mm] drive impact wrench
- (1) 10 mm hex bit 1/2" [12.5 mm] drive universal socket
- (1) 3/4" [19 mm] open end wrench

Step #3

Remove (12) M12 lower cross-drive clamp bolts and (6) clamps. Then pry the drive rods away from the cross-drives.

Requires:

- (1) 1/2" [12.5 mm] drive impact wrench
- (1) 10 mm hex bit 1/2" [12.5 mm] drive universal socket
- (1) Pry bar

Step #1

If possible, cycle all three cross-drives to the fully retracted (rear, unload) position. (Note: This step makes it easier to line up the threaded pads during assembly.)

Step #2

Clean the area around the pressure & return lines with shop towels. Place a bucket under the connections and remove the lines.

Requires:

- (1) 7/8" [22 mm] open end wrench
- (1) 1" [25 mm] open end wrench

It is not necessary to remove the (4) M12 bolts or the (2) plates. The replacement cylinder pack comes with these already attached.

Step #5

Loosen, but do not remove all (10) M12 cylinder pack mounting bolts. (They will support the cylinder pack.)

Requires:

- (1) 1/2" [12.5 mm] drive impact wrench
- (1) 10 mm hex bit 1/2" [12.5 mm] drive universal socket
- (1) 1/2" [12.5 mm] swivel drive extension is very helpful

Step #6

Support the cylinder pack 45-50 lbs [20-23 kg], then remove all (10) M12 manifold mounting bolts. The cylinder pack should be free to lower out of the frame.

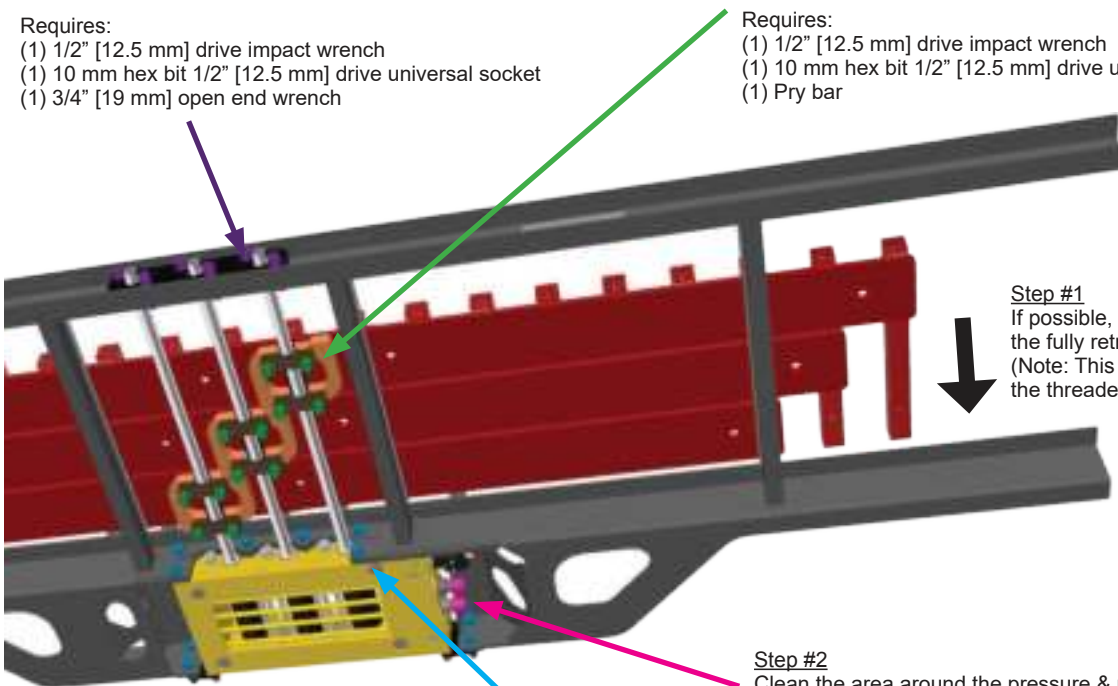

65000

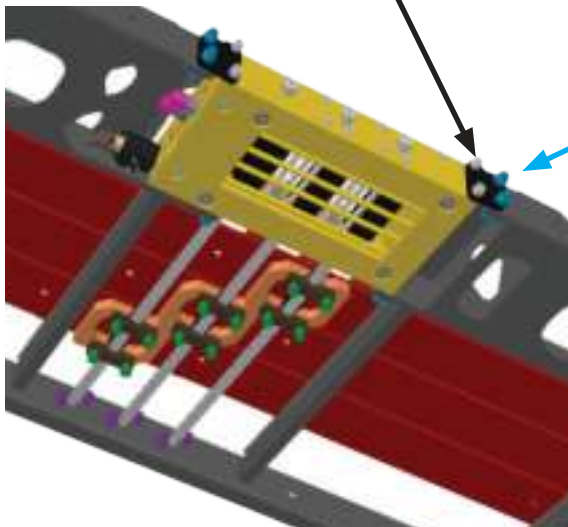

Cylinder Pack Installation

Step #1

If all three cross-drives were fully retracted to the rear, unload end of the trailer before removing the old cylinder pack, then the threaded rod pads should be in the correct positions for installation. Skip to step #2.

If the cross-drives were not fully retracted before removing the old cylinder pack, then the (6) check valves, poppets and springs will need to be removed from the new cylinder pack prior to installation (see previous section regarding Check Valve Replacement). This will relieve hydraulic pressure and allow the rods to be moved into the correct positions to properly engage the upper cross-drive threaded clamps.

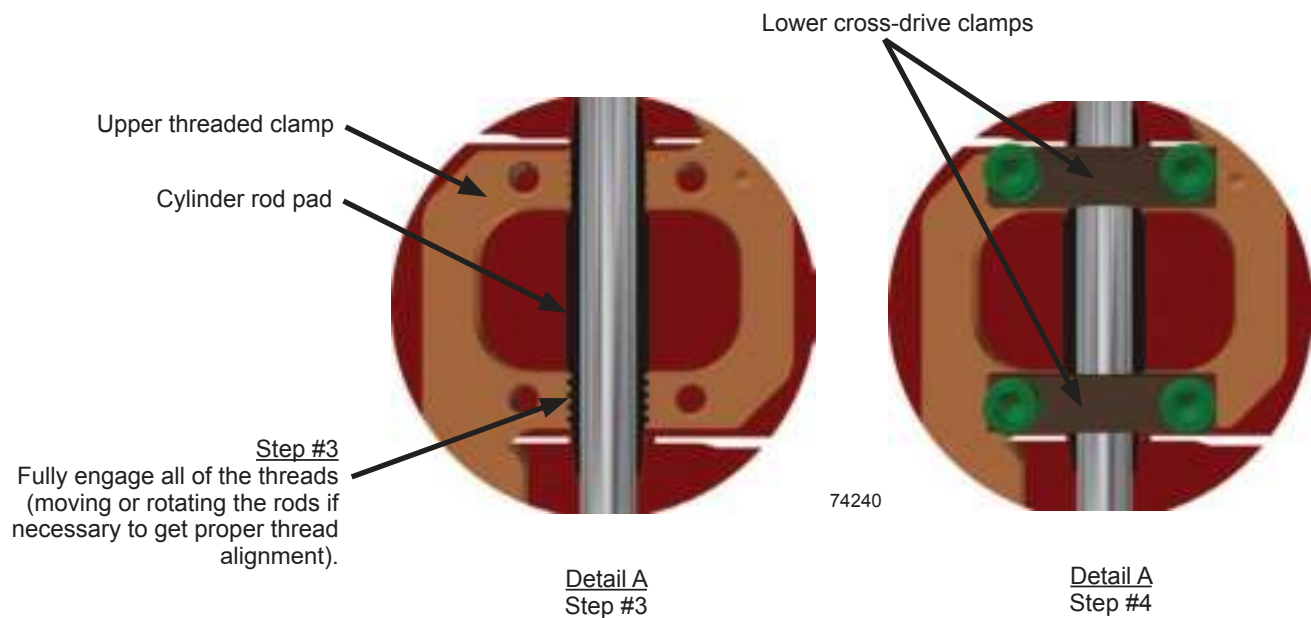
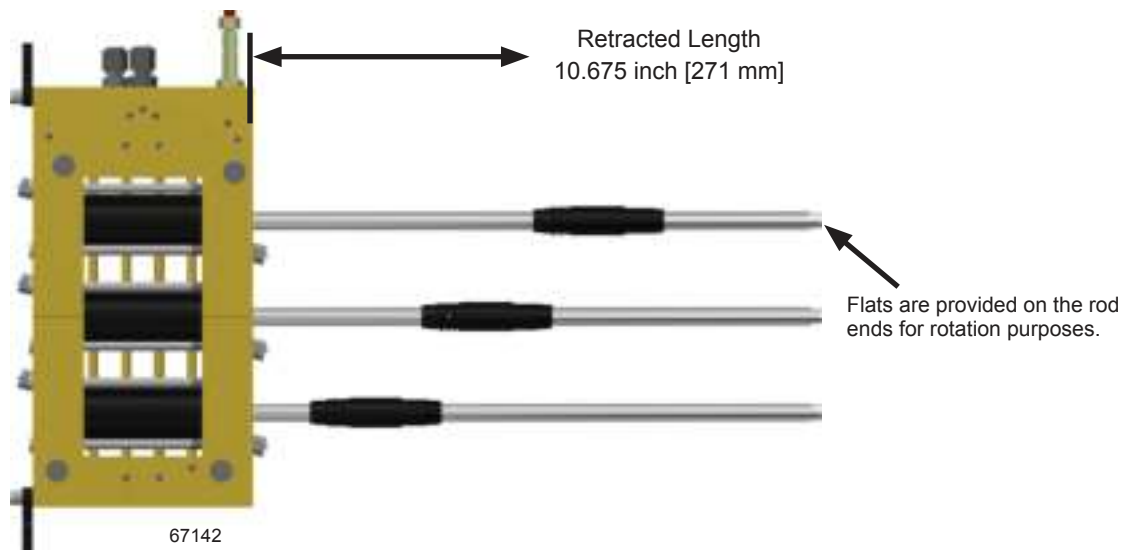

Cylinder Pack Installation

Step #4 See Detail A
Reinstall (6) lower cross-drive clamps using blue thread locker on the bolts.
Torque (12) M12 bolts with lock washers
Requires:
(1) 1/2" [12.5 mm] drive impact wrench
(1) 10 mm hex bit 1/2" [12.5 mm] drive universal socket
(1) 1/2" [12.5 mm] drive torque wrench

Step #3 See Detail A
Center the threaded cylinder rod pads on the upper threaded clamps of the cross-drives.

Step #5
Reinstall rod bearing block and cover plate (preferably a new one) using the (6) M12 bolts and Nylock nuts (preferably new Nylock nuts) and tighten until snug ((Do Not Overtighten)).
Requires:
(1) 1/2" [12.5 mm] drive impact wrench
(1) 10 mm hex bit 1/2" [12.5 mm] drive universal socket
(1) 3/4" [19 mm] open end wrench

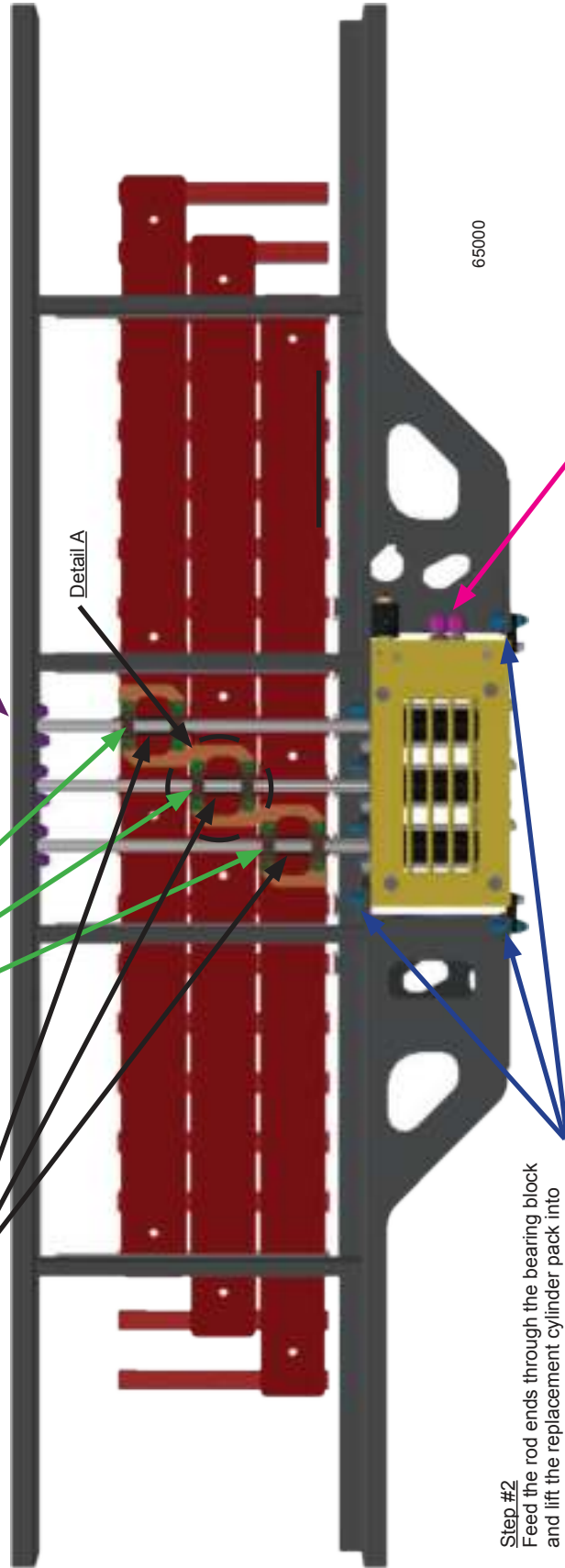

Step #2
Feed the rod ends through the bearing block and lift the replacement cylinder pack into position in the drive frame. Loosely place the (10) M12x40 mm bolts through the manifold and frame to hold the cylinder pack in place.

Step #7
Reconnect pressure and return lines.
Requires:
(1) 7/8" [22 mm] open end wrench
(1) 1" [25 mm] open end wrench

Step #6
Evenly torque the (10) M12 cylinder pack bolts
Requires:
(1) 1/2" [12.5 mm] drive impact wrench
(1) 10 mm hex bit 1/2" [12.5 mm] drive universal socket
(1) 1/2" [12.5 mm] swivel drive extension is very helpful
(1) 1/2" [12.5 mm] drive torque wrench

Step #8
If check valves were removed to allow for rod adjustment, carefully reinstall per the Check Valve Replacement instructions in previous section.

Step #9
Run the floor and check for leaks.

5.4 Technical Support

Please have the following information readily available before contacting KEITH for support:

- Model Number (Located on the Serial Plate of the drive unit) (See 3.3 Component Location Diagram)
- Serial Number (Located on the Serial Plate of the drive unit) (See 3.3 Component Location Diagram)
- Quantity & length of floor slats
- Vehicle make and unit installer

KEITH Technical Support Contact Information:

Website: www.KeithWalkingFloor.com

Email: TechDept@KeithWalkingFloor.com

Toll-Free: (800) 547-6161

Phone: +1-541-475-3802

6.0 Contact Information - KEITH Manufacturing Co.

World Headquarters - USA

401 NW Adler St.

P.O. Box 1

Madras, OR 97741

Toll-Free: 800-547-6161

Phone: +1-541-475-3802

Email: Sales@KeithWalkingFloor.com

Canada

Brantford, ON

Phone: +1-519-756-9178

Email: CanadaSales@KeithWalkingFloor.com

México

Guadalajara, Jal.

Phone: +52-333-616-5079

Email: KMC_Mexico@KeithWalkingFloor.com

Australia

Waverley Gardens, VIC

Phone: +61-3-9562-2190

Email: AUSales@KeithWalkingFloor.com

Europe

Barneveld, The Netherlands

Phone: +31-342-422007

Email: EuroSales@KeithWalkingFloor.com

(Final Page)