

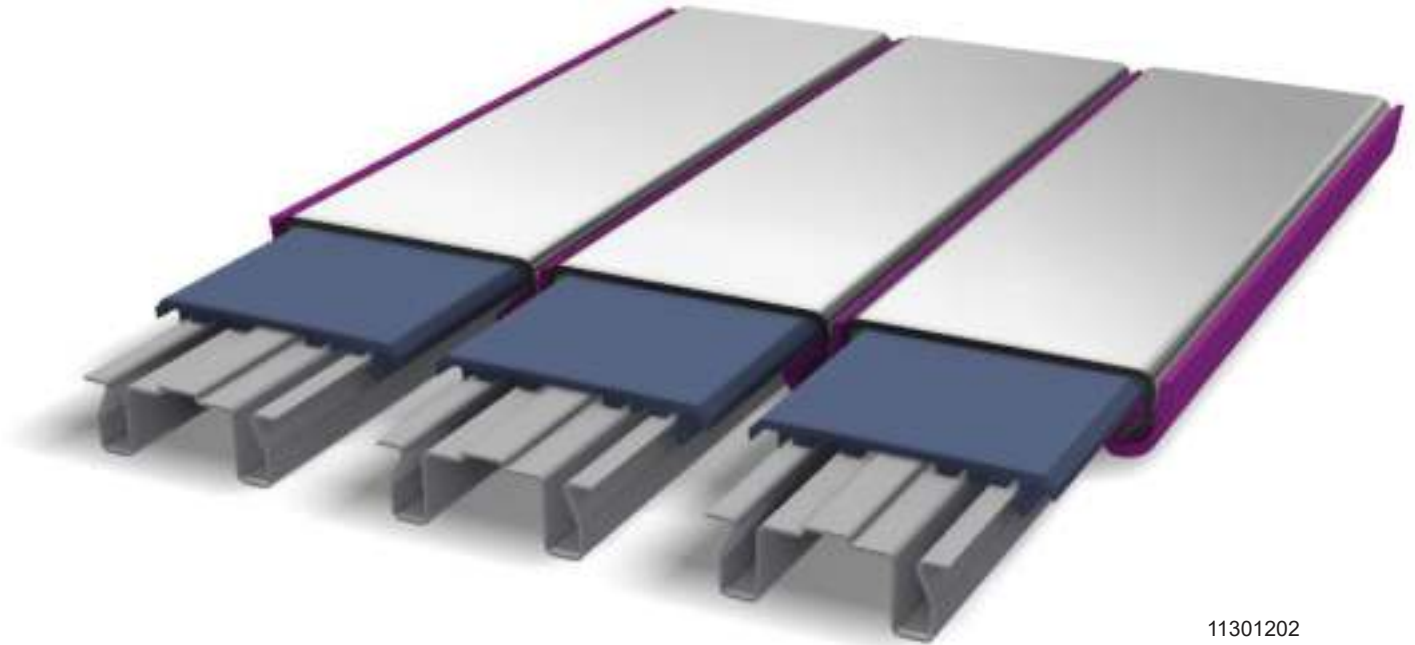

J-MAX™ FLOORING with Steel Sub-Deck

KEITH Manufacturing Co.
www.KeithWalkingFloor.com
World Headquarters
Toll-Free: 800-547-6161
Phone: +1-541-475-3802



11301202

INSTALLATION MANUAL with RUNNING FLOOR II DRIVE



Original Instructions

©2022 KEITH Manufacturing Co. All Rights Reserved. KEITH, KEITH logo and WALKING FLOOR are registered trademarks of KEITH Manufacturing Co. Equipment manufactured by KEITH Manufacturing Co. is protected by numerous patents both domestic and foreign.

Released: 2022-10-17

DOC06823 Rev. G

Table of Contents

Introduction	1
1.0 Floor Slat Assembly Details	2
2.0 Pre-Order Information Required	4
2.1 Dimensions 'A' & 'B' Measured from Trailer	4
2.2 Determine Quantity of Floor Slats	5
3.0 Installation Instructions	6
3.1 Crossmember Requirements & Baffle Plate Installation	6
3.2 Sub-Deck & Side Seal Installation	8
3.3 Bearings & Slat Installation	11
3.4 Floor Slat Attachment Instructions	13
3.5 J-Seal Seating Instructions	14
3.6 Fabricate & Install Front Slope Shield	15
Technical Support	16
Contact Information - KEITH Manufacturing Co.	16

Introduction

This manual explains procedures for installing 4-5/16 inch [109.5 mm] KEITH® J-MAX™ Flooring with steel sub-deck in trailers with steel crossmembers and a KEITH® *WALKING FLOOR*® unloading system. Many variables affect the installation, but the general process remains constant. Details of the installation vary according to trailer features, kit selections, and installer preferences. Optional instructions are given for some operations to allow for flexibility.

Installation time varies and is between 25 to 50 man hours, depending upon the experience of the installer and the adaptability of the trailer. If the trailer is not yet built, there are some trailer preparations provided in Section 3.0 that will save time and effort. One person with welding skills can complete the entire installation.

Several reference drawings are included in this manual. The appropriate KEITH® *WALKING FLOOR*® Owner Operator Manual contains more detailed information about the system and operation procedures.

Direct any questions to KEITH Manufacturing Co. or one of our international offices listed on our website.

1.0 Floor Slat Assembly Details

A. J-MAX slat assembly as supplied by KEITH Manufacturing Co. (See Figure 1)

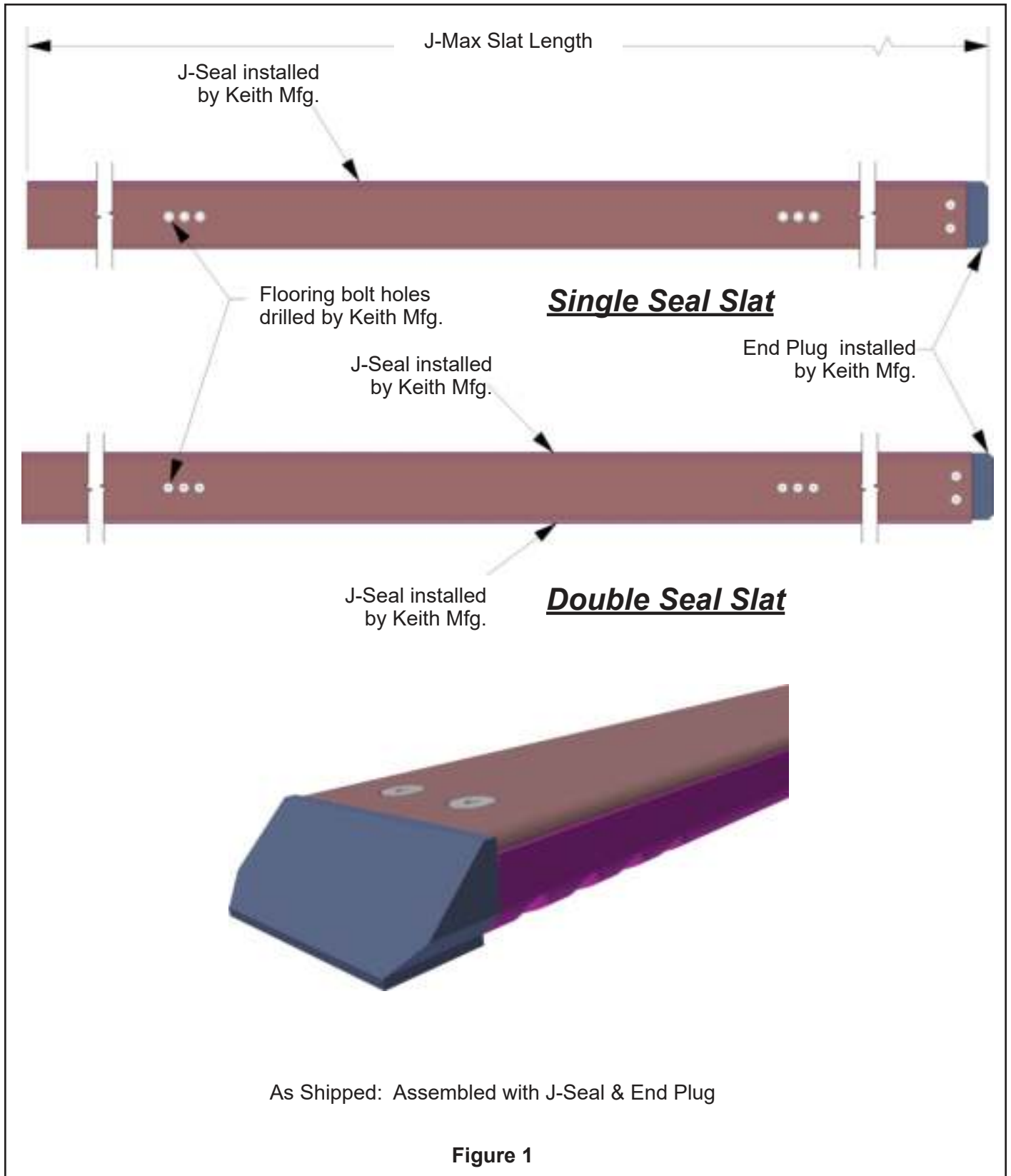

Figure 1

B. J-MAX slat assembly detail. (See Figure 2)

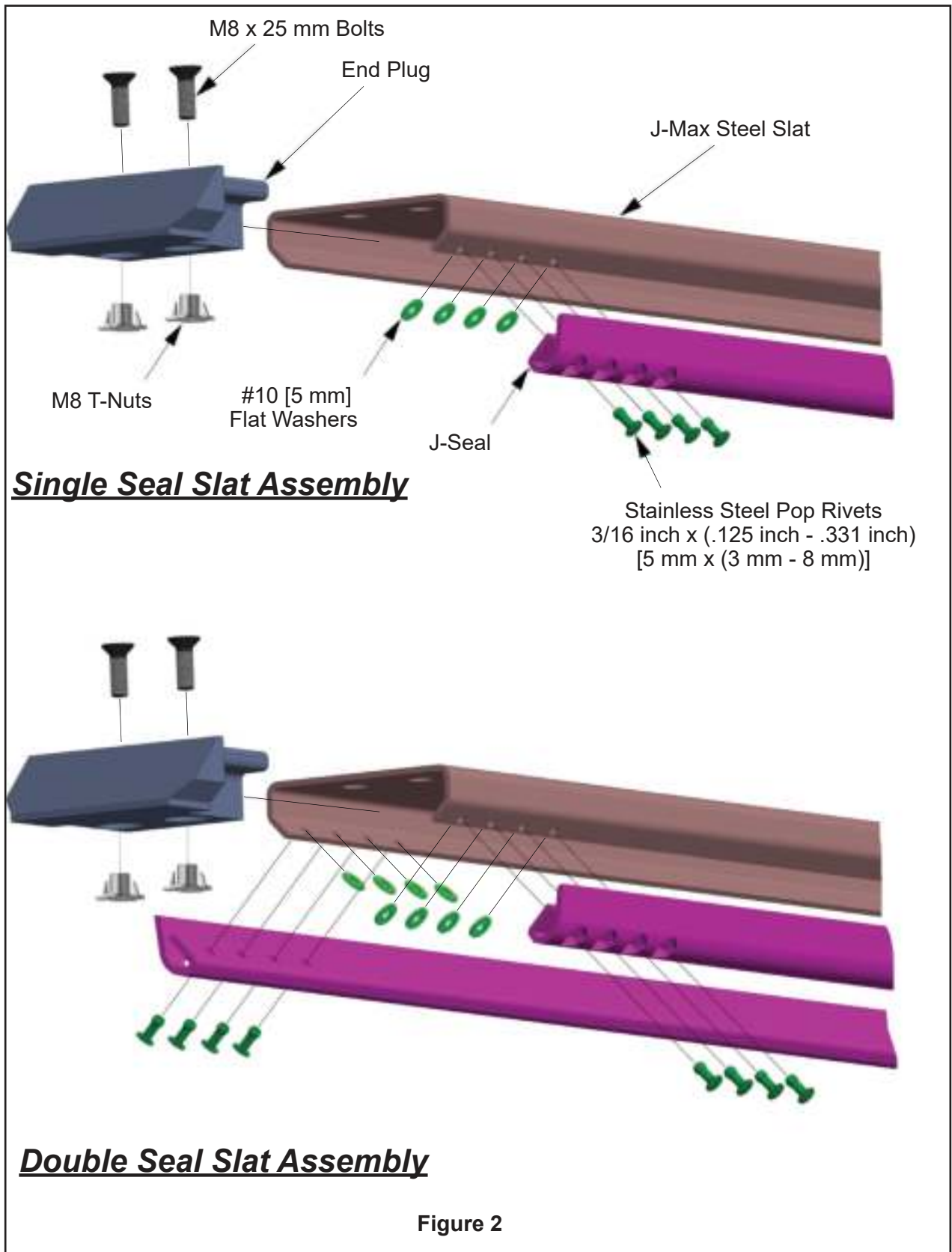

Figure 2

Dimensions for drives with an 8 inch [203 mm] stroke length

Dimensions for drives with an 10 inch [254 mm] stroke length

2.0 Pre-Order Information Required

2.1 Dimensions 'A' & 'B' Measured from Trailer

'A' = Measured inside length of trailer from inside front bulkhead wall to inside rear door

'B' = Measured distance from forward most crossmember at rear of drive opening to inside rear door

(See Figure 3)

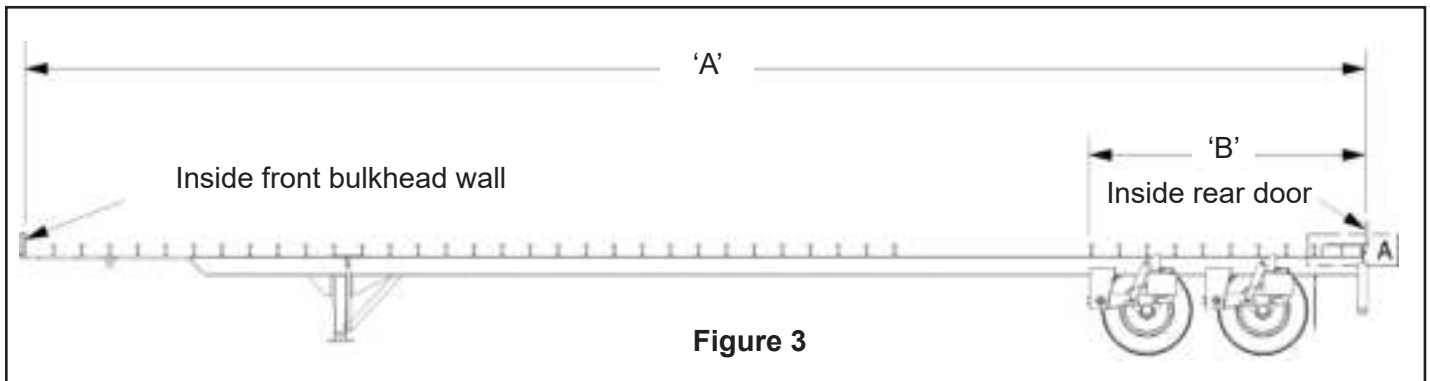

Reference drawing # 11378501 for component dimensioning with RFI drive.

2.2 Determine Quantity of Floor Slats

Use the formula below to determine the quantity of floor slats needed and the width of the side seals required. (See Figure 4)

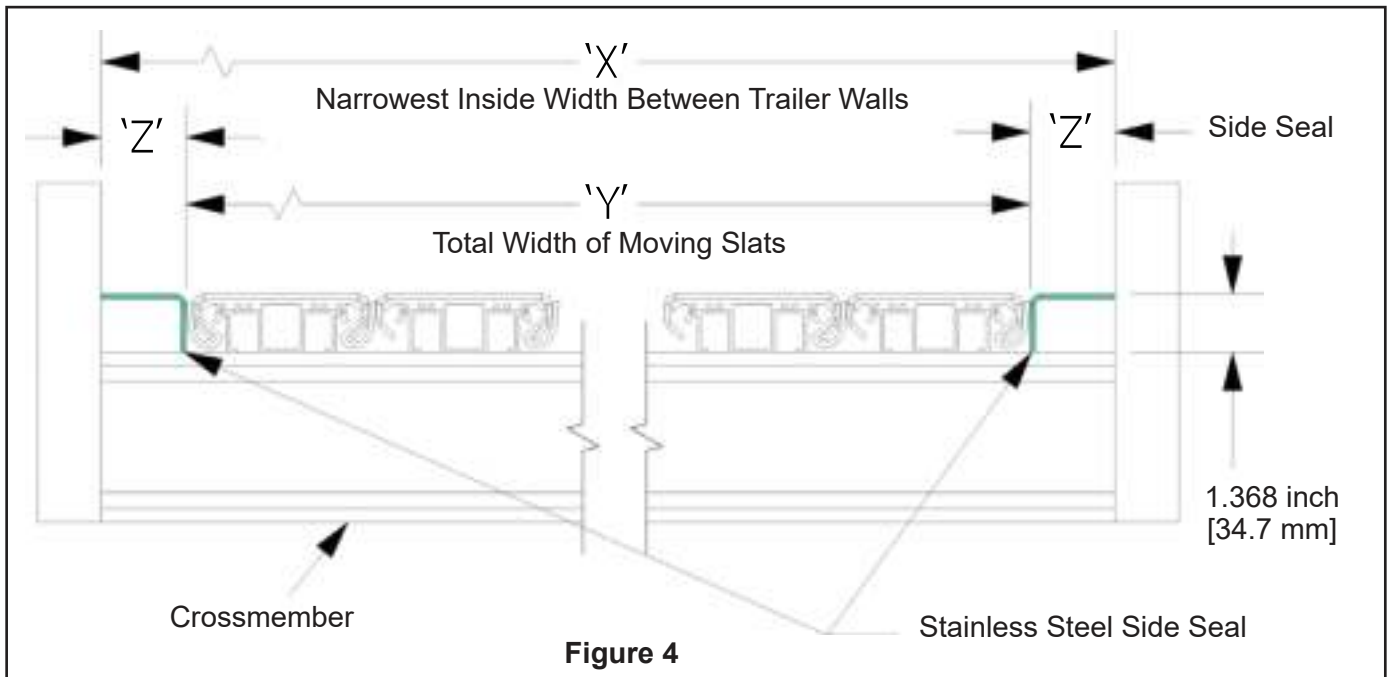

$$('X' - 'Y') / 2 = 'Z'$$

J-Max Flooring 4-5/16 inch [109.5 mm] Slat Centers

X = Distance Across Trailer	N = Number of Moving Slats	Y = (N * 4.3125 inch) + .175 inch	Z*2 = Combined Width of Side Seals		
	15	64.86 inch [1647.5 mm]			
	16	69.18 inch [1757.0 mm]			
	17	73.49 inch [1866.6 mm]			
	18	77.80 inch [1976.1 mm]			
	19	82.11 inch [2085.7 mm]			
	20	86.43 inch [2195.2 mm]			
	standard 21	90.74 inch [2304.7 mm]			
	22	95.05 inch [2414.3 mm]			
Examples	96.74 inches	21	90.74 inches	6 inches	Z=3 inches Z=67 mm
	2438.7 mm	21	2304.7 mm	134 mm	

3.0 Installation Instructions



NOTE: When welding, ground specifically to what you are welding on, otherwise it can short across component assemblies damaging seals and gaskets.

3.1 Crossmember Requirements & Baffle Plate Installation

Crossmembers function as support for the sub-deck.

1. Recommended crossmember spacing is 12 inch [305 mm] centers.

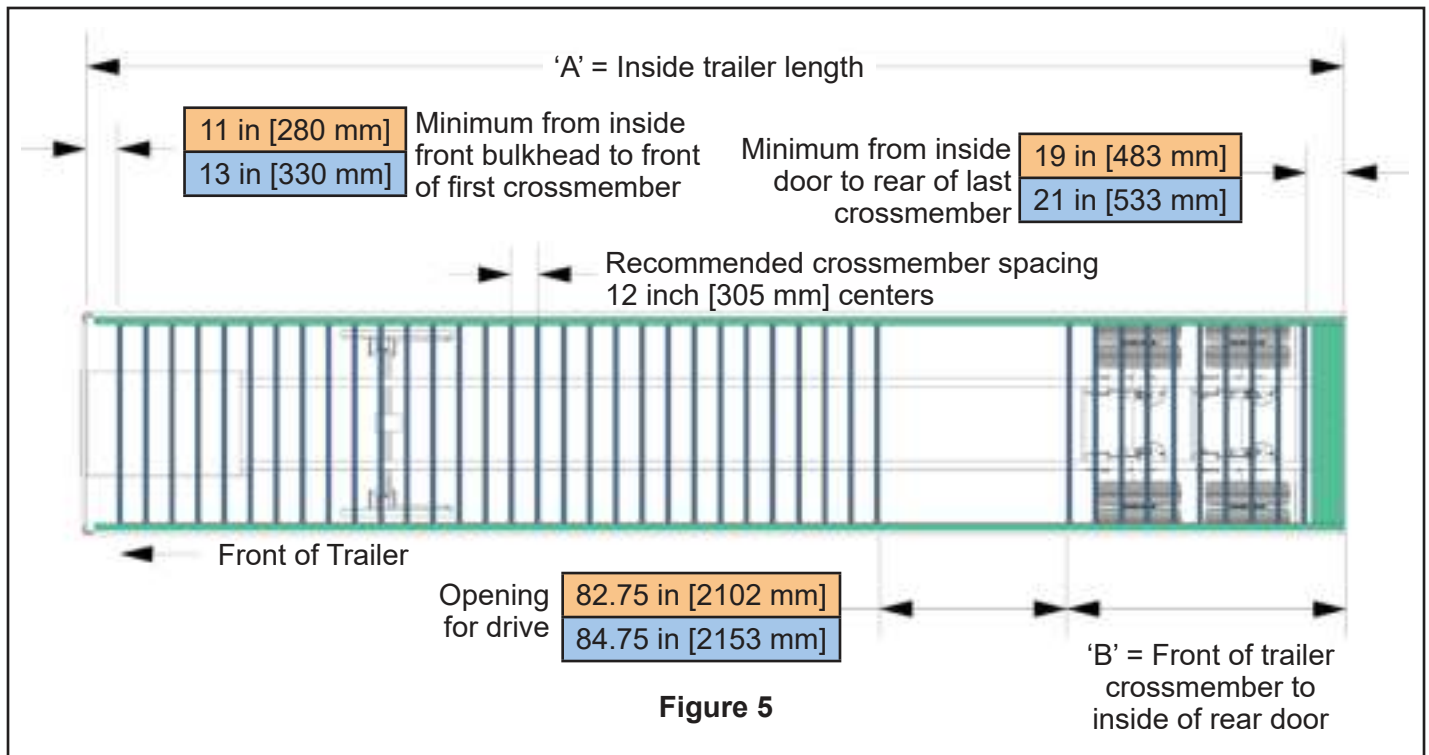
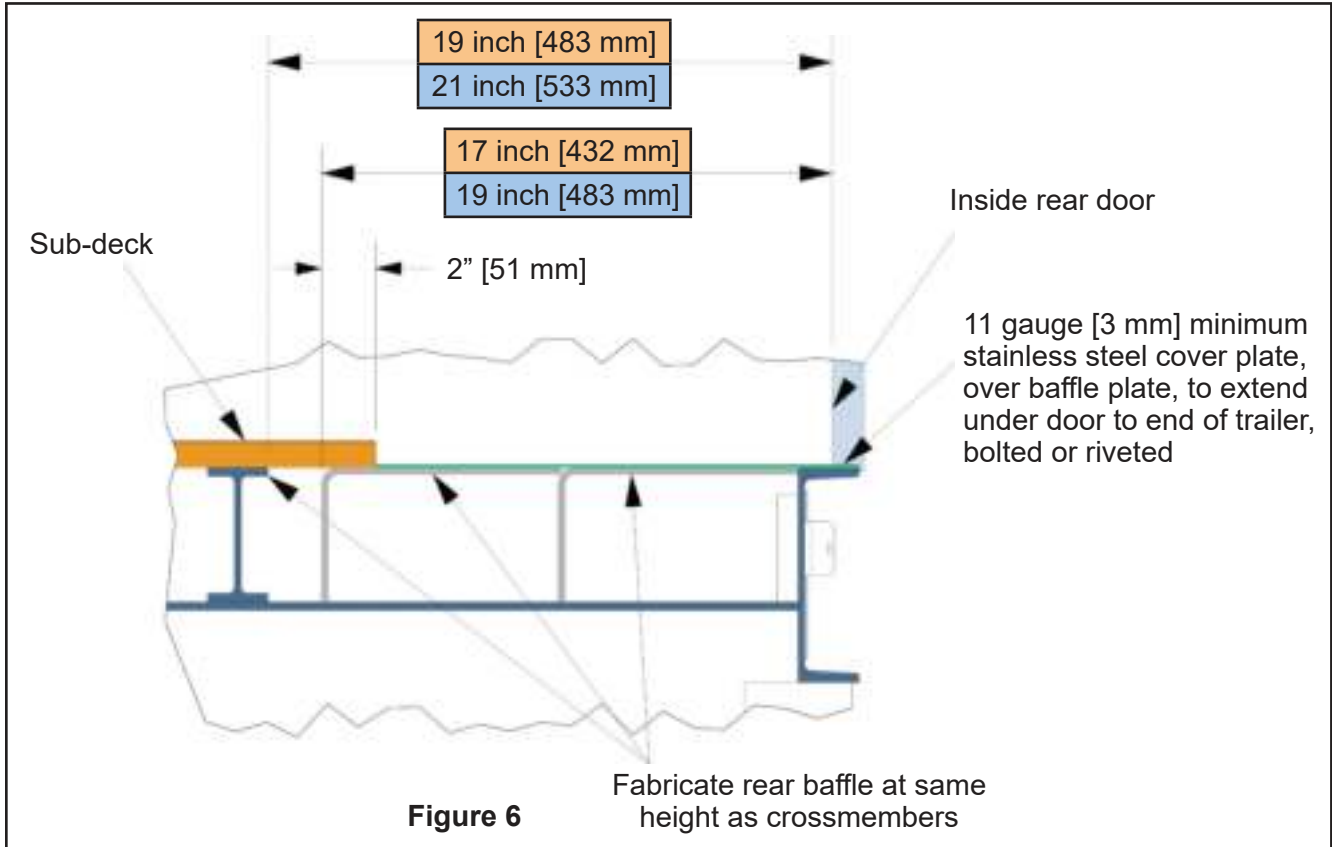
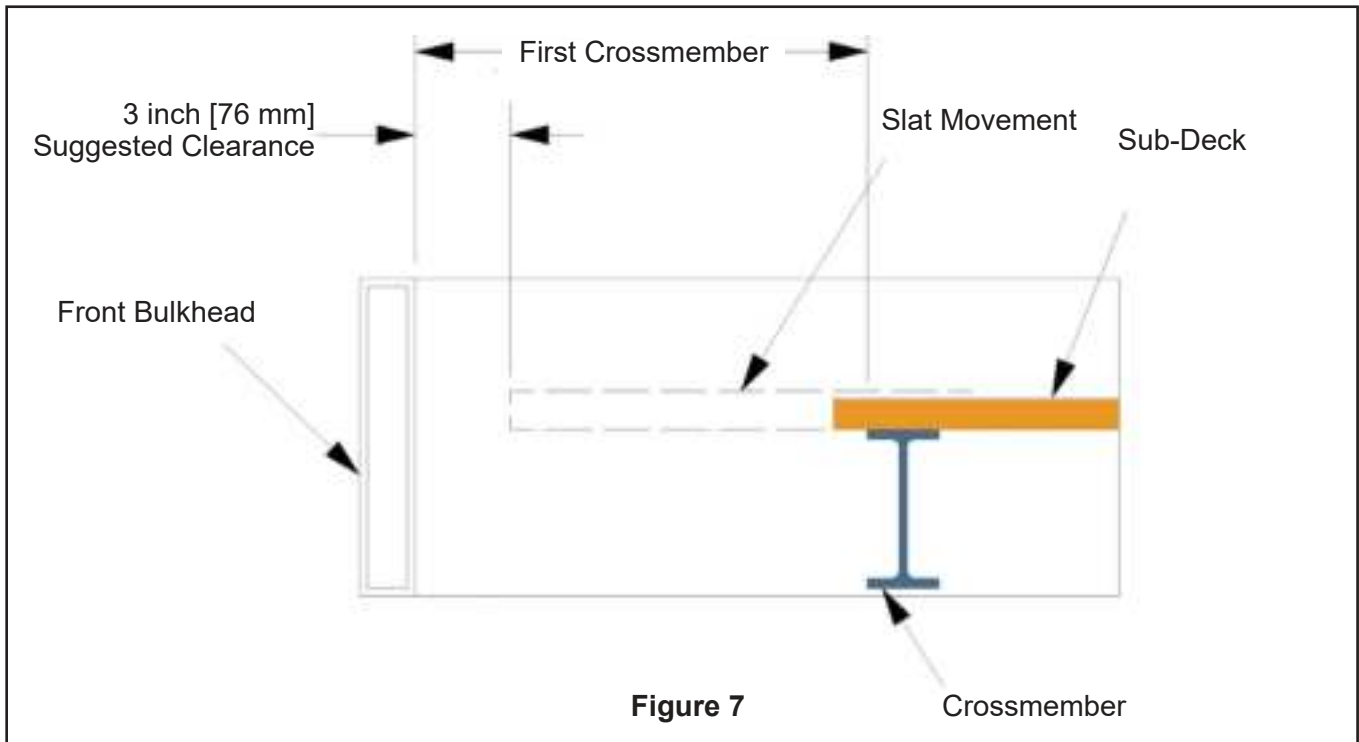

Figure 5

2. Baffle Plate Installation: A baffle plate extends forward from the door threshold to prevent material from sifting through the floor when slats are in the forward position.
 - A. Determine the dimensions of the baffle plate (Figure 6). The baffle plate must be level with the crossmembers and is welded to the inside of the last beam of the trailer (threshold). The thickness depends on the type of load. We recommend 11 gauge [3 mm] plate for heavy, abrasive materials (e.g. solid waste). The front of plate should be bent to meet the trailer frame, leaving an opening between the formed plate and the last crossmember so that material will not build up underneath the slats.
 - B. Cut and form the baffle plate to the proper dimensions.
 - C. Install the baffle plate, welding the plate in position and grind welds flat. Make sure the plate is level with the crossmembers. (See Figure 6)



3. Locate the first crossmember at the front of the trailer at a minimum of 11 inch [280 mm] from front bulkhead of trailer. (See Figure 7) 13 inch [330 mm]



3.2 Sub-Deck & Side Seal Installation

1. Cut sub-decks to proper length according to your trailer measurements and the position of the drive assembly. (See Figure 8)

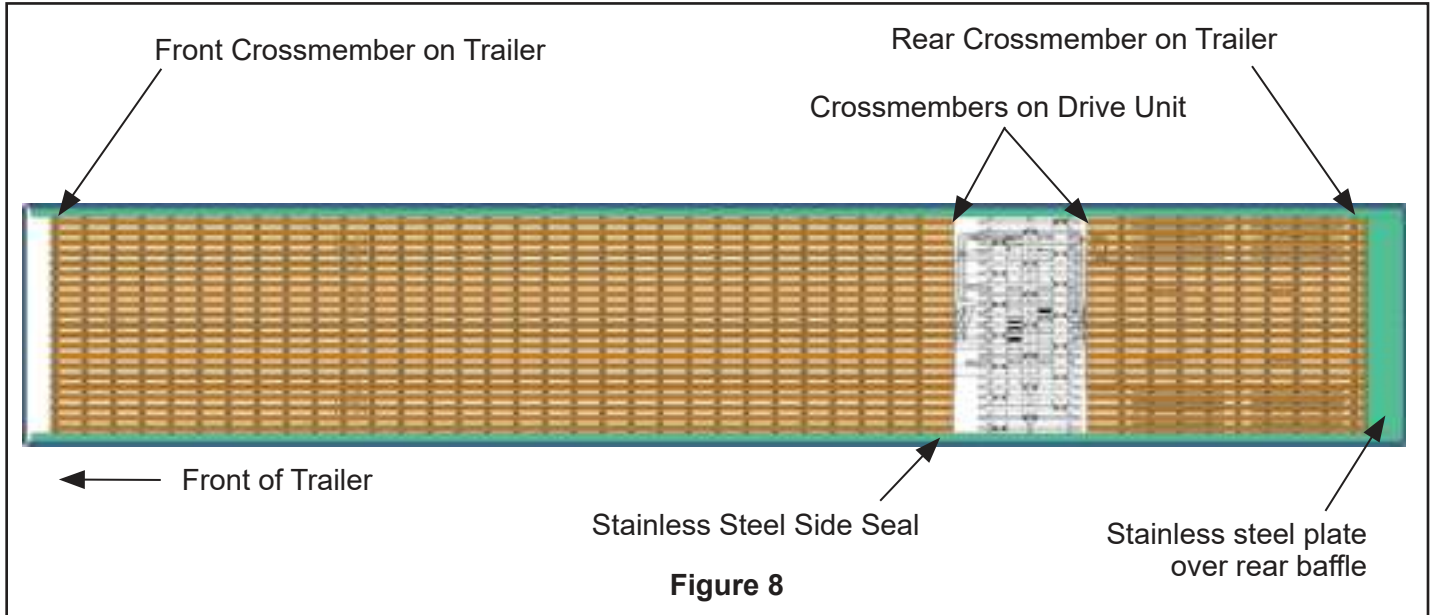

2. Attach sub-deck to crossmembers by welding. Proper installation of the sub-deck is critical for maintaining floor alignment, floor straightness and for optimal performance of the J-Seal located between the floor slats. (See Figure 9)

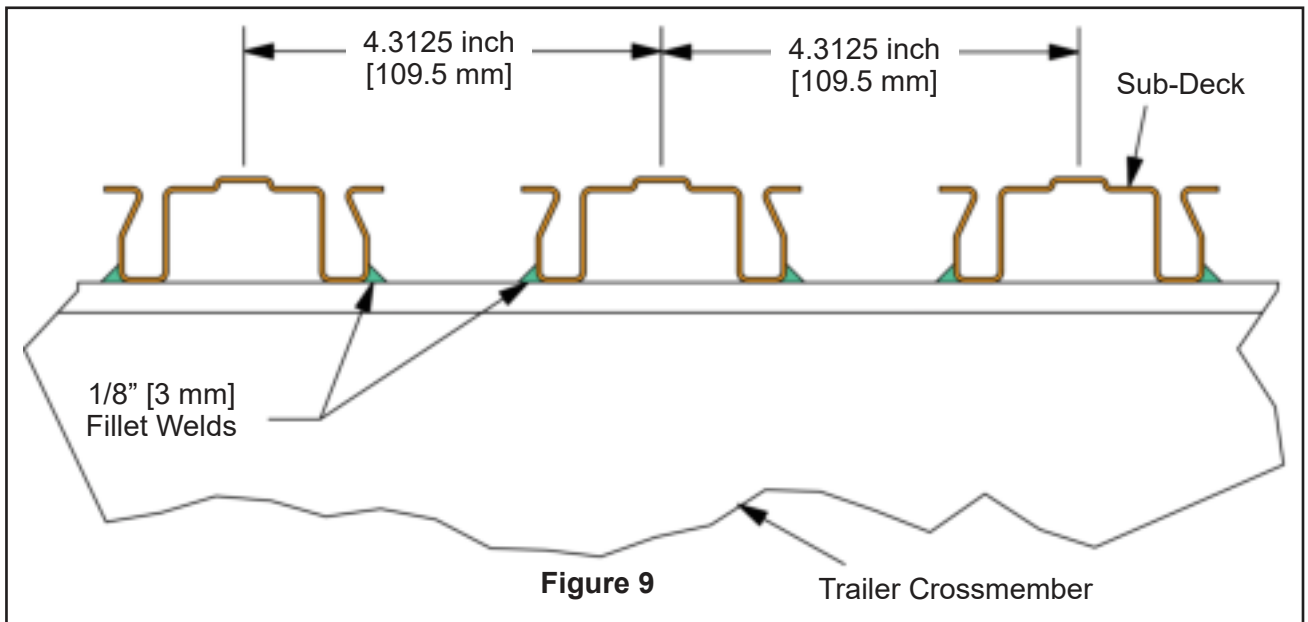

3. Start at the rear of the trailer. Locate one set of sub-decks using the center line marked on the sub-deck jig, aligning it with the center line of the trailer. Clamp the jig and sub-deck to the crossmembers, then attach the sub-deck to the crossmembers. This will align the sub-deck with the shoe on the drive. (Figure 10)

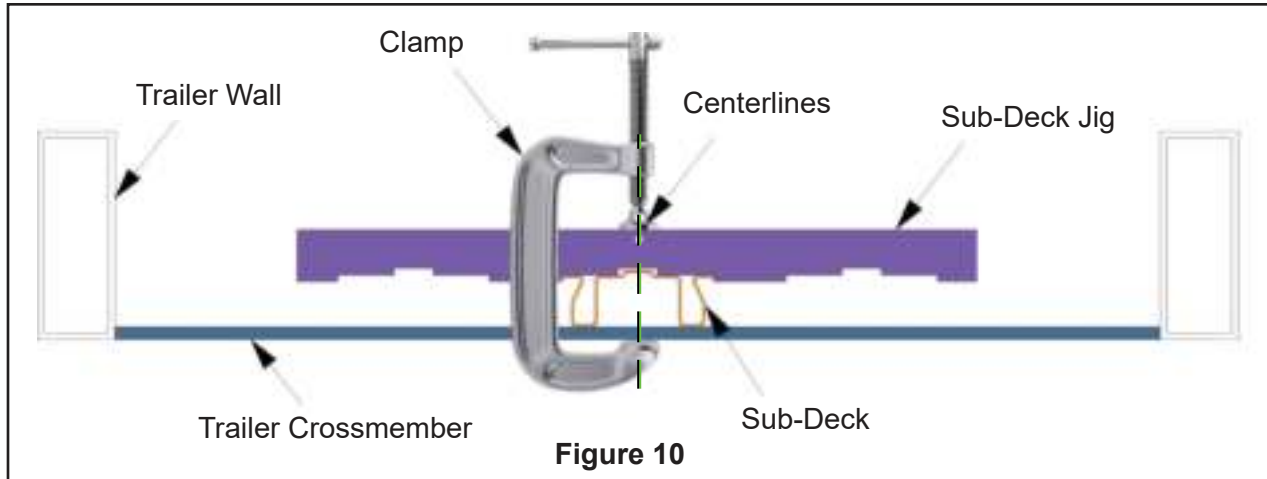

4. Lay out the remaining sub-decks and stainless steel side seals with supports across the width of the trailer using the spacing jigs for proper location. Keeping the jigs above the crossmembers, clamp the jig and sub-decks to every other crossmember. Remember to attach the sub-decks to the formed crossmembers that are attached to the drive unit. (See Figures 11 & 12)

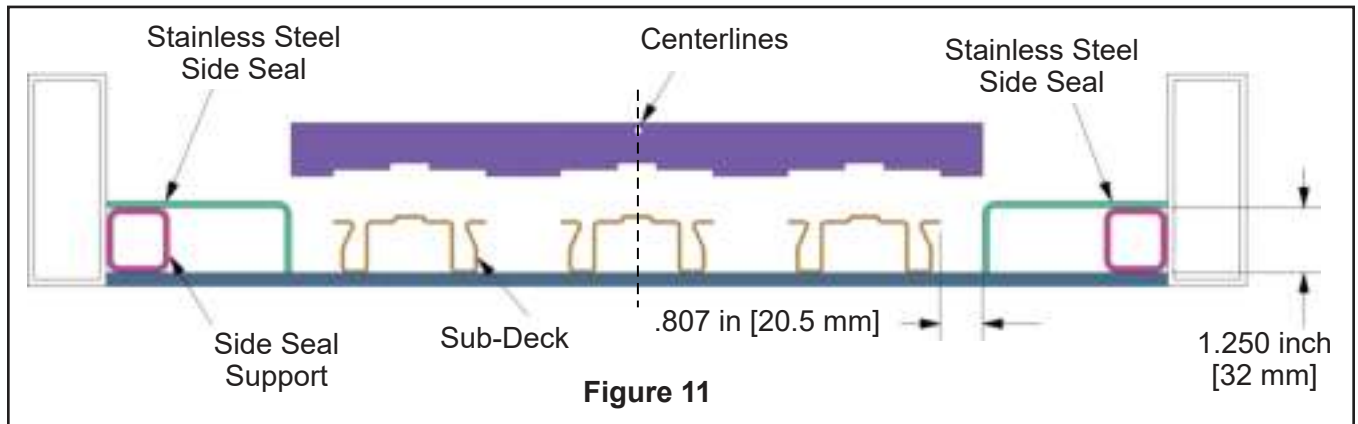

5. Install stainless steel side seal before moving the sub-deck spacing jigs. If splicing the side seal, grind welds smooth or J-seal will not seal properly. Side seal must be supported across drive opening. (Figure 12)

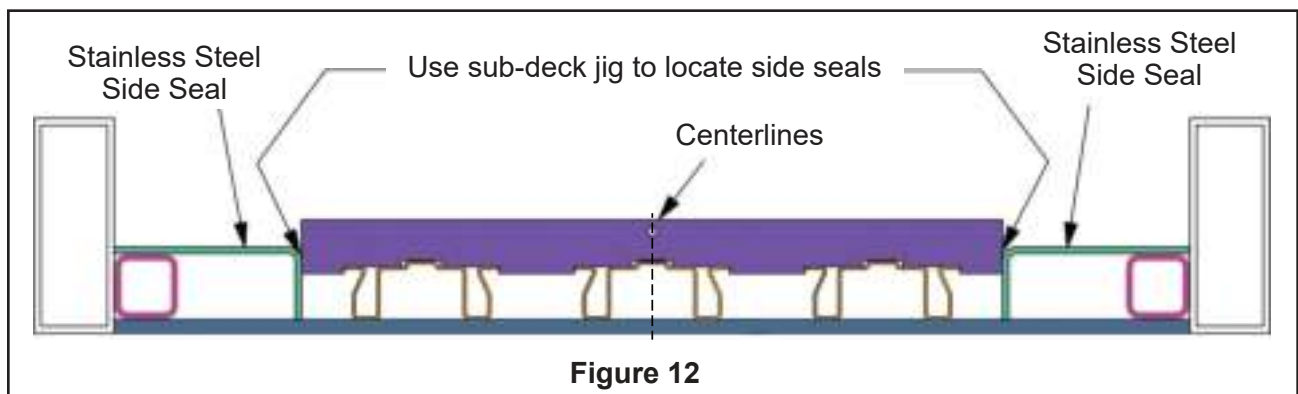

- Weld the sub-decks to the crossmembers between the jigs. Move the jigs and make a connection at each intersection of a sub-deck and a crossmember. Welds should be 1/8 inch [3 mm] fillet, 5/8 inch to 3/4 inch [15 mm to 20 mm] long, and centered on the flange. Excessive welding and too little cooling will cause crossmembers to warp.

Use suggested welding pattern below. Starting each pass on the same side of the trailer gives sufficient cooling time before second pass. (See Figure 13)

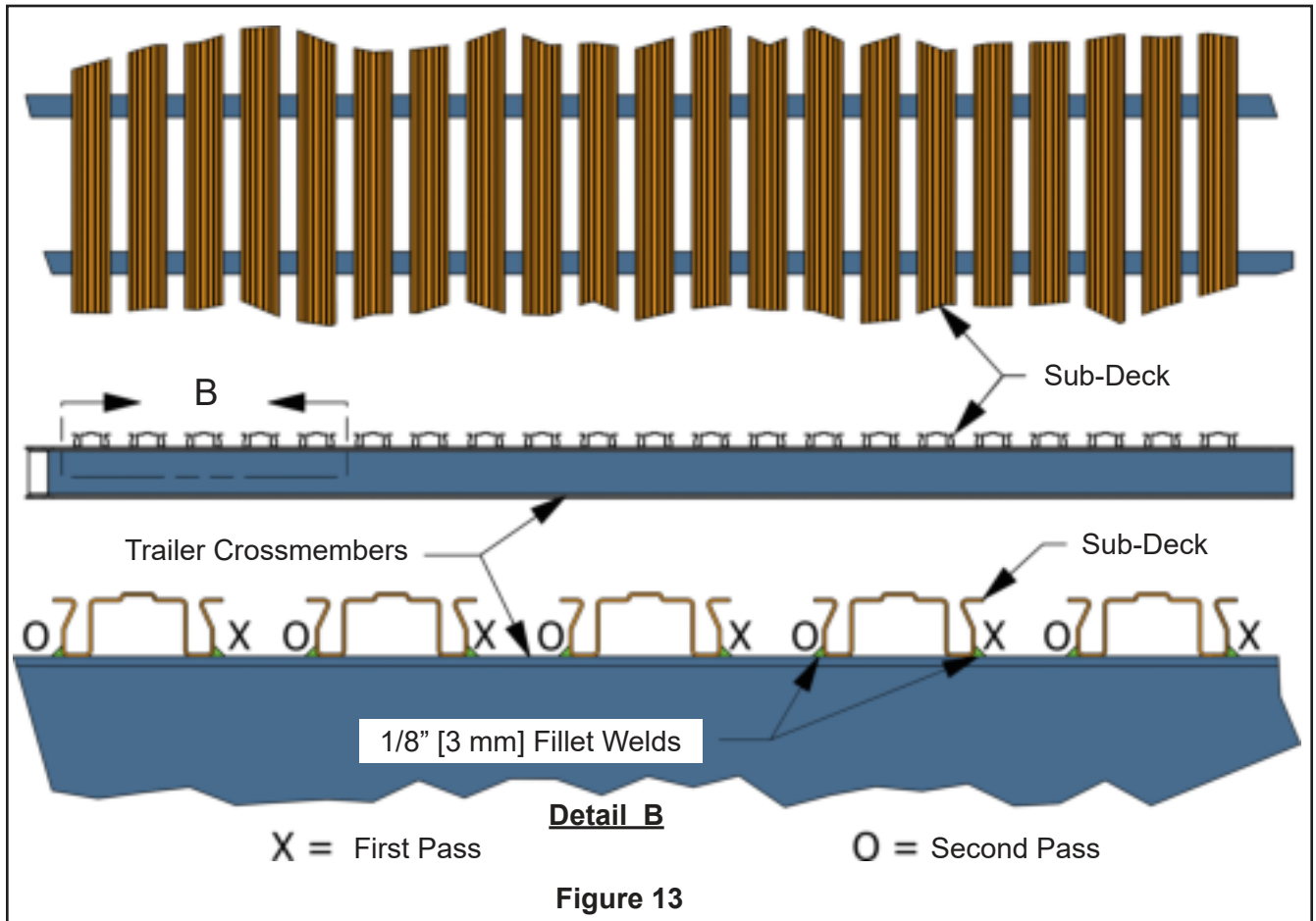

3.3 Bearings & Slat Installation

Bearings Snapped Down onto Sub-Deck, Slats Slid Over Bearings (with Bearing Stops)

1. Bearing Stops keep bearings in place and are installed with pop rivets. Slide bearing stops onto the ends of the sub-deck in the appropriate orientation and flush with the ends of the sub-decks. Drill (6) holes through sub-deck, using holes in bearing stops as a drill jig. Install (6) rivets per bearing stop. (4) Bearing Stops per slat are pre-drilled and supplied by KEITH Mfg. with order. (See Figure 14)

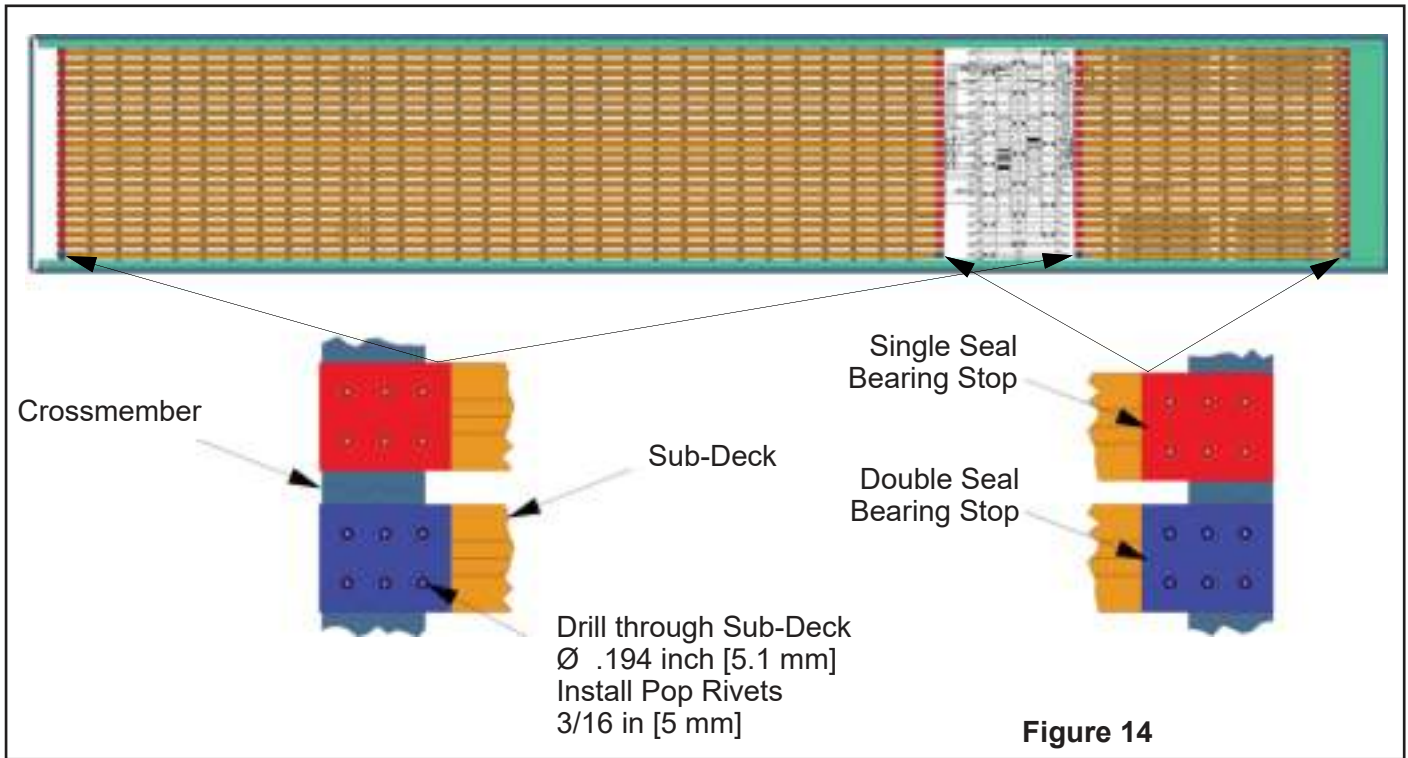

Single Seal Bearing Stop



Double Seal Bearing Stop

2. Bearings come in 6 ft [1829 mm] lengths and snap down over sub-deck. (See Figure 15)

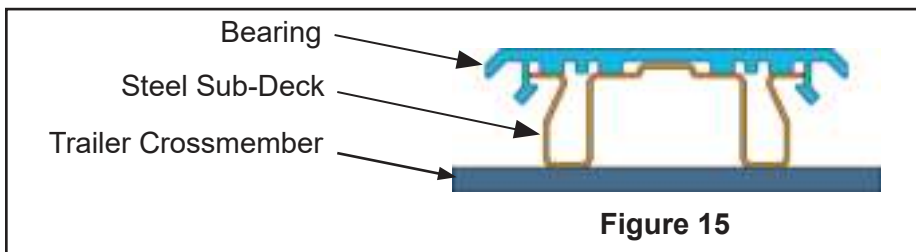

3. Pre-cut bearings where needed to fit between the bearing stops on the sub-deck, as shown. Total bearing length should be 3 inches [76 mm] shorter than the distance between bearing stops to allow for expansion of bearings. (See Figure 16)
4. Snap bearings down into place.

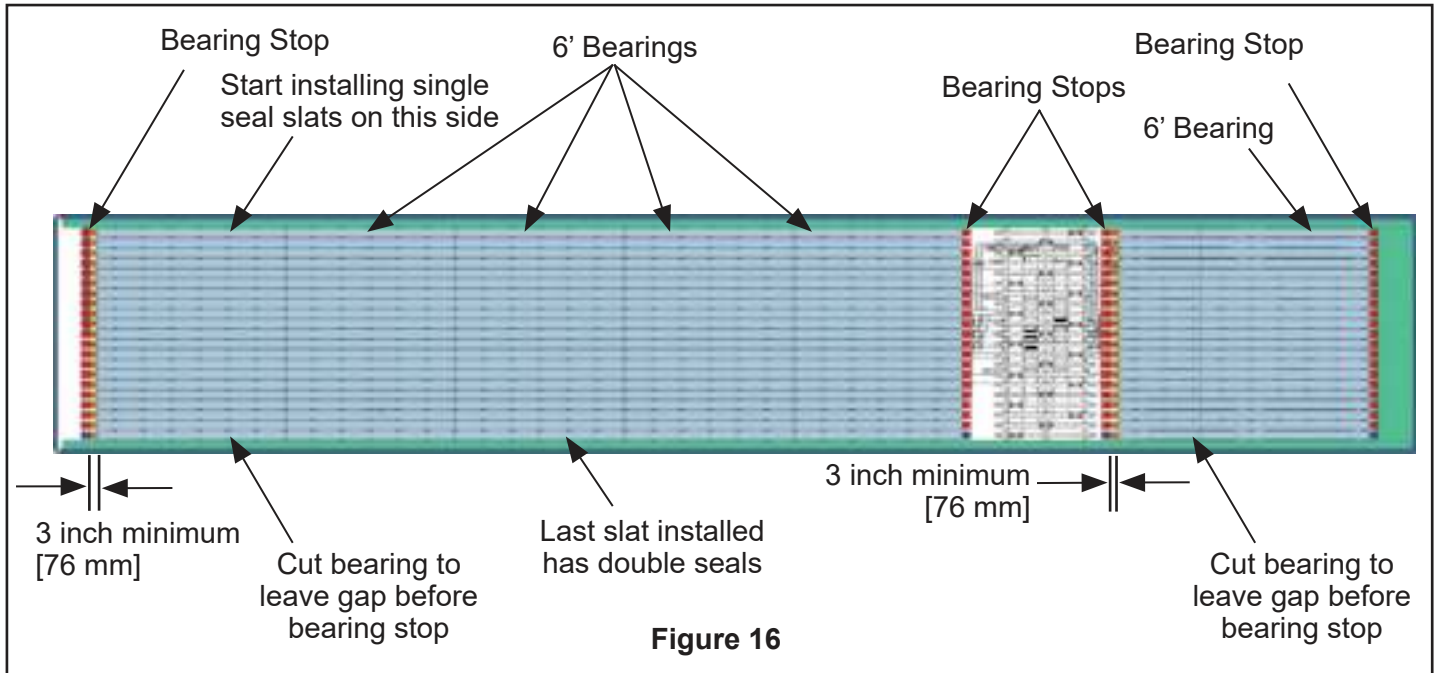

5. **Ensure J-Seals are fully seated along the entire length of slats (install position).** Starting on the right side of the trailer, slide the single seal pre-assembled floor slats over the bearings, until the pre-drilled holes line up with the holes in the drive shoes. The last slat installed on the left side of the trailer will have double seals. (See Figure 17)

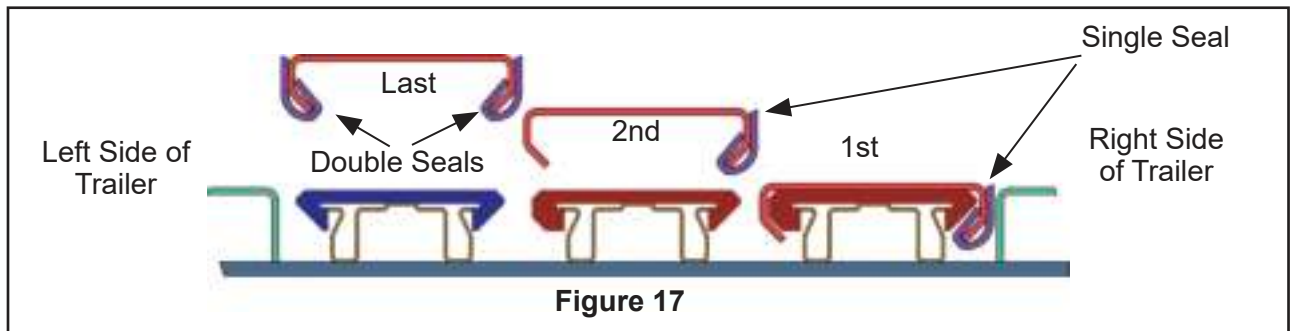

3.4 Floor Slat Attachment Instructions

1. Make final adjustments of all floor slats until the pre-drilled holes in the slats line up with the appropriate holes in the cross-drive shoes.
2. Bolt Slats to Cross-Drive Shoes

NOTE: *Bolt slats to cross-drive shoes before seating floor J-Seal.*

Bolt Torque Chart						
Bolt (SAE)	Grade	Torque (ft/lbs)	Location	Bolt (Metric)	Grade	Torque (Nm)
-	-	-	End Plugs	M8 x 1.25	10.9	34
5/16-18	8	24	Floor Bolts	M8 x 1.25	10.9	34
3/8-16	8	45	Floor Bolts	M10 x 1.5	10.9	66

3.5 J-Seal Seating Instructions

1. Image shows the end view of the assembled slats in position (J-Seal is in the raised installed position). (See Figure 30)

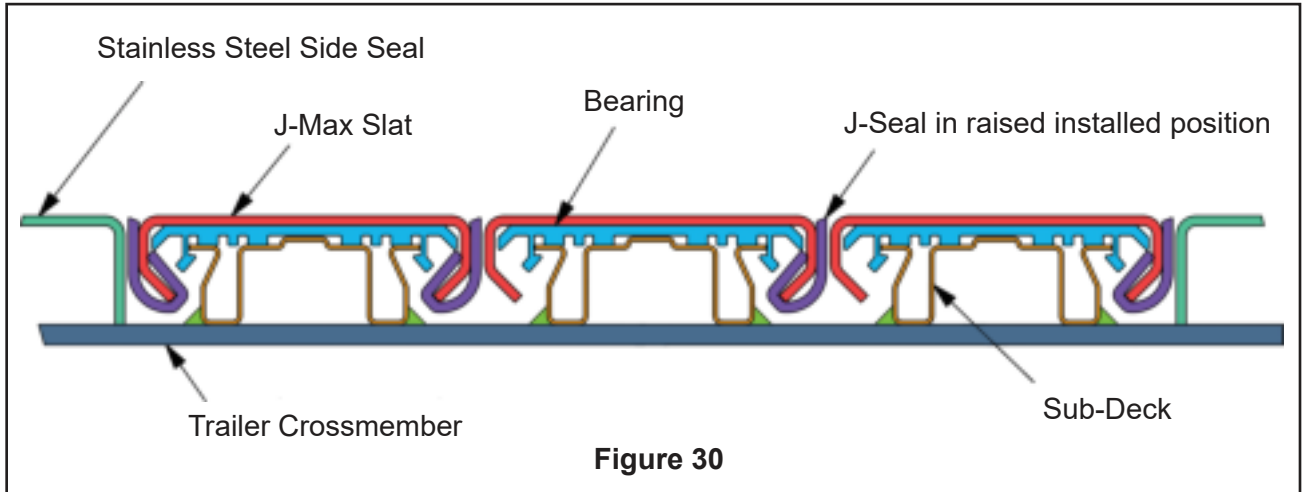

2. Push J-Seal down until tool stops. Image shows the slat assembly end view with the J-Seal in the seated position. (See Figure 31)

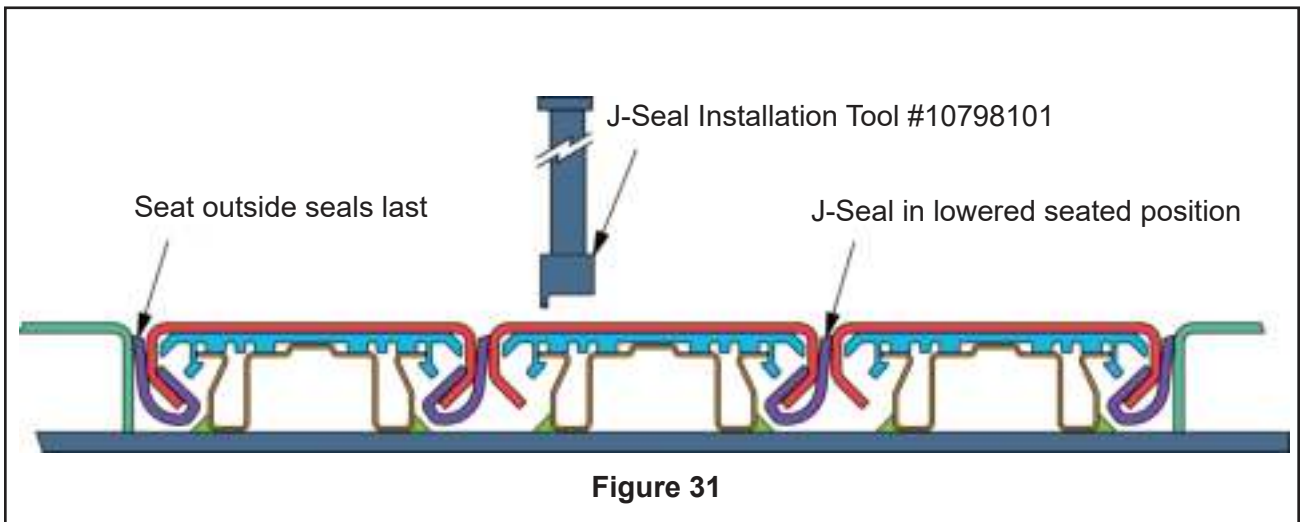

3.6 Fabricate & Install Front Slope Shield

1. Determine Slope Shield & Support Dimensions: The width is equal to the inner trailer width. The front shield is commonly installed at approximately 45° between the front wall and the flooring. The UHMW wear strip should lie fully on top of the floor slats when the floor slats are in the rear position (at maximum distance from the front wall). (Figures 32 & 33)
2. Fabricate Sloped Front Shield & Supports: Form the slope shield plate and attach steel angles for added support. Rivet the plastic wear strip to the bottom of the shield. (Figures 32 & 33)
3. Mount Supports & Front Shield: Bolt or weld angled supports to the side walls. Bolt the slope shield to the front of the trailer and to the side supports. Turn Buckles can be added to hold the front slope shield down onto the slats. Clean-out holes can be provided below the front shield to reduce potential material buildup. (Figures 32 & 33)

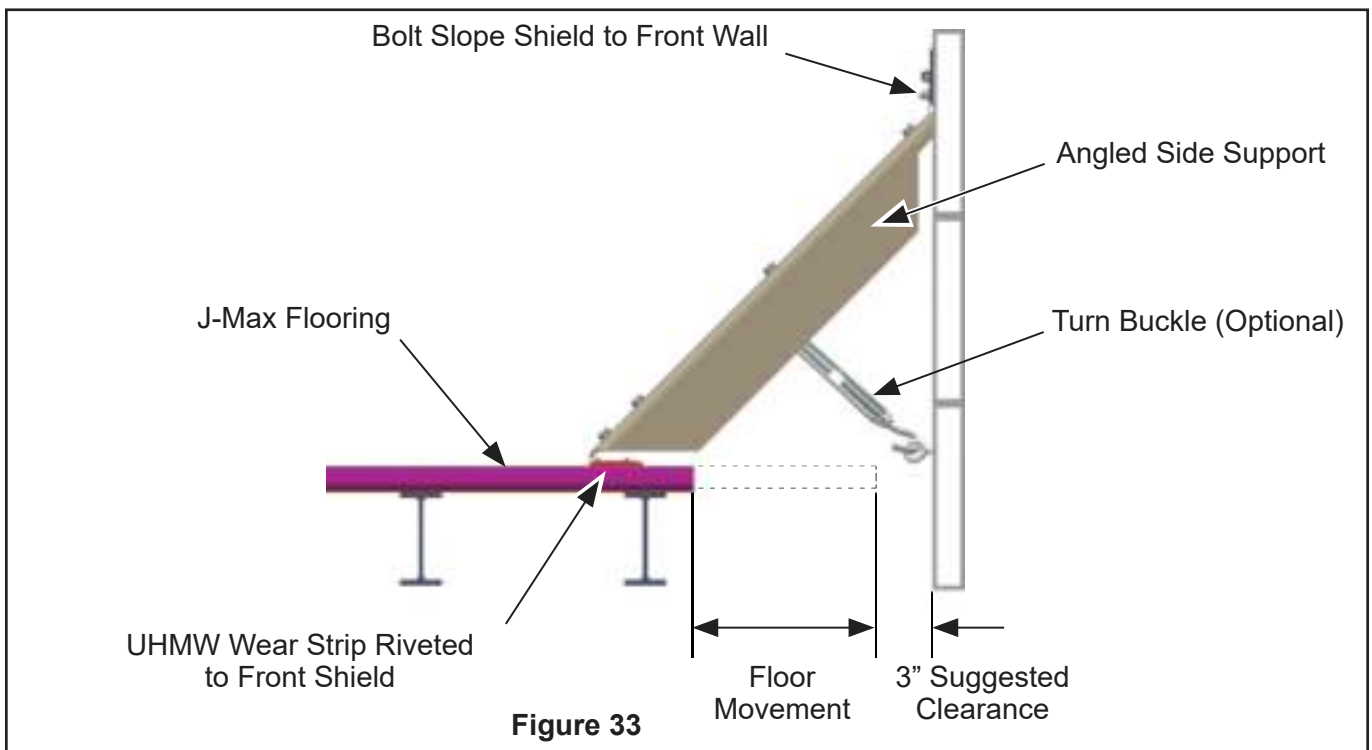
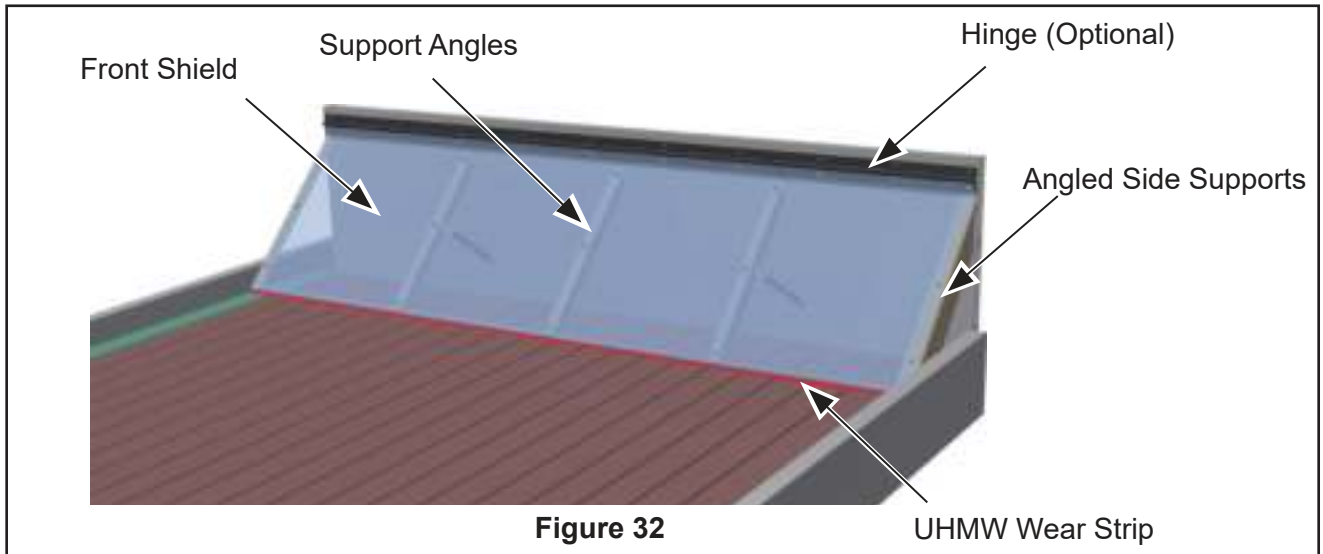

Technical Support

Please have the following information readily available before contacting KEITH for support:

- Model Number (Located on the Serial Plate of the drive unit) (See Drive Owner's Manual 3.3 Component Location Diagram)
- Serial Number (Located on the Serial Plate on the drive unit) (See Drive Owner's Manual 3.3 Component Location Diagram)
- Quantity & length of floor slats
- Vehicle make and unit installer

KEITH Technical Support Contact Information:

Website: www.KeithWalkingFloor.com

Email: TechDept@KeithWalkingFloor.com

Toll-Free: +1-800-547-6161

Phone: +1-541-475-3802

Contact Information - KEITH Manufacturing Co.

KEITH WALKING FLOOR India Private Limited

Paragon 4B - 26
Phoenix Marketcity
LBS Marg, Kurla, Mumbai, Maharashtra 400070
Tel: +91-44-48526805
Email: Solutions@KeithWalkingFloor.in

World Headquarters - USA

401 NW Adler St.
P.O. Box 1
Madras, OR 97741
Toll-Free: 800-547-6161
Phone: +1-541-475-3802
Email: Sales@KeithWalkingFloor.com

Europe

Barneveld, The Netherlands
Phone: +31-342-422007
Email: EuroSales@KeithWalkingFloor.com

Canada

Brantford, ON
Phone: +1-519-756-9178
Email: CanadaSales@KeithWalkingFloor.com

México

Guadalajara, Jal.
Phone: +52-333-616-5079
Email: KMC_Mexico@KeithWalkingFloor.com

Australia

Waverley Gardens, VIC
Phone: +61-3-9562-2190
Email: AUSales@KeithWalkingFloor.com